



650V series

Frames C, D, E & F

HA467652U002 Issue 11
Technical Manual

aerospace
climate control
electromechanical
filtration
fluid & gas handling
hydraulics
pneumatics
process control
sealing & shielding



ENGINEERING YOUR SUCCESS.



650V AC Drive

Frame C, D, E & F

Product Manual

HA467652U002 Issue 11

Compatible with Version 4.9 Software onwards

2013 Parker Hannifin Manufacturing Ltd.

All rights strictly reserved. No part of this document may be stored in a retrieval system, or transmitted in any form or by any means to persons not employed by a Parker company without written permission from Parker Hannifin Manufacturing Ltd. Although every effort has been taken to ensure the accuracy of this document it may be necessary, without notice, to make amendments or correct omissions. Parker Hannifin Manufacturing Ltd cannot accept responsibility for damage, injury, or expenses resulting therefrom.

WARRANTY

All orders are subject to Parker Hannifin Manufacturing Ltd Terms and Conditions of Sale for Goods and/or Services. Terms and conditions of purchase of goods and/or services.

The general terms and conditions of sale of goods and/or services of Parker Hannifin Europe Sarl, Luxembourg, Switzerland Branch, Etoy, apply to this product unless otherwise agreed. The terms and conditions are available on our website www.parker.com/termsandconditions/switzerland

FAILURE OR IMPROPER SELECTION OR IMPROPER USE OF THE PRODUCTS DESCRIBED HEREIN OR RELATED ITEMS CAN CAUSE DEATH, PERSONAL INJURY AND PROPERTY DAMAGE.

This document and other information from Parker-Hannifin Corporation, its subsidiaries and authorized distributors provide product or system options for further investigation by users having technical expertise.

The user, through its own analysis and testing, is solely responsible for making the final selection of the system and components and assuring that all performance, endurance, maintenance, safety and warning requirements of the application are met. The user must analyze all aspects of the application, follow applicable industry standards, and follow the information concerning the product in the current product catalog and in any other materials provided from Parker or its subsidiaries or authorized distributors.

To the extent that Parker or its subsidiaries or authorized distributors provide component or system options based upon data or specifications provided by the user, the user is responsible for determining that such data and specifications are suitable and sufficient for all applications and reasonably foreseeable uses of the components or systems.

Safety Information



Requirements

IMPORTANT: Please read this information BEFORE installing the equipment.

Intended Users

This manual is to be made available to all persons who are required to install, configure or service equipment described herein, or any other associated operation.

The information given is intended to highlight safety issues, EMC considerations, and to enable the user to obtain maximum benefit from the equipment.

Complete the following table for future reference detailing how the unit is to be installed and used.

INSTALLATION DETAILS	
Model Number <i>(see product label)</i>	
Where installed <i>(for your own information)</i>	
Unit used as a: <i>(refer to Certification for the Inverter)</i>	<input type="radio"/> Component <input type="radio"/> Relevant Apparatus
Unit fitted:	<input type="radio"/> Wall-mounted <input type="radio"/> Enclosure



Application Area

The equipment described is intended for industrial motor speed control utilising DC motors, AC induction or AC synchronous machines

Personnel

Installation, operation and maintenance of the equipment should be carried out by qualified personnel. A qualified person is someone who is technically competent and familiar with all safety information and established safety practices; with the installation process, operation and maintenance of this equipment; and with all the hazards involved.

Product Warnings

 Caution Risk of electric shock	 Caution Refer to documentation	 Earth/Ground Protective Conductor Terminal
--	--	--

Safety Information



Hazards

DANGER! - Ignoring the following may result in injury

1. This equipment can endanger life by exposure to rotating machinery and high voltages.
2. The equipment must be permanently earthed due to the high earth leakage current, and the drive motor must be connected to an appropriate safety earth.
3. Ensure all incoming supplies are isolated before working on the equipment. Be aware that there may be more than one supply connection to the drive.
4. There may still be dangerous voltages present at power terminals (motor output, supply input phases, DC bus and the brake, where fitted) when the motor is at standstill or is stopped.
5. For measurements use only a meter to IEC 61010 (CAT III or higher). Always begin using the highest range. CAT I and CAT II meters must not be used on this product.
6. Allow at least 5 minutes for the drive's capacitors to discharge to safe voltage levels (<50V). Use the specified meter capable of measuring up to 1000V dc & ac rms to confirm that less than 50V is present between all power terminals and earth.
7. Unless otherwise stated, this product must NOT be dismantled. In the event of a fault the drive must be returned. Refer to "Routine Maintenance and Repair".

WARNING! - Ignoring the following may result in injury or damage to equipment

SAFETY

Where there is conflict between EMC and Safety requirements, personnel safety shall always take precedence.

- Never perform high voltage resistance checks on the wiring without first disconnecting the drive from the circuit being tested.
- Whilst ensuring ventilation is sufficient, provide guarding and /or additional safety systems to prevent injury or damage to equipment.
- When replacing a drive in an application and before returning to use, it is essential that all user defined parameters for the product's operation are correctly installed.
- All control and signal terminals are SELV, i.e. protected by double insulation. Ensure all external wiring is rated for the highest system voltage.
- Thermal sensors contained within the motor must have at least basic insulation.
- All exposed metalwork in the Inverter is protected by basic insulation and bonded to a safety earth.
- RCDs are not recommended for use with this product but, where their use is mandatory, only Type B RCDs should be used.

EMC

- In a domestic environment this product may cause radio interference in which case supplementary mitigation measures may be required.
- This equipment contains electrostatic discharge (ESD) sensitive parts. Observe static control precautions when handling, installing and servicing this product.
- This is a product of the restricted sales distribution class according to IEC 61800-3. It is designated as "professional equipment" as defined in EN61000-3-2. Permission of the supply authority shall be obtained before connection to the low voltage supply.

CAUTION!

APPLICATION RISK

- The specifications, processes and circuitry described herein are for guidance only and may need to be adapted to the user's specific application. We can not guarantee the suitability of the equipment described in this Manual for individual applications.

RISK ASSESSMENT

Under fault conditions, power loss or unintended operating conditions, the drive may not operate as intended.

In particular:

- Stored energy might not discharge to safe levels as quickly as suggested, and can still be present even though the drive appears to be switched off
- The motor's direction of rotation might not be controlled
- The motor speed might not be controlled
- The motor might be energised

A drive is a component within a drive system that may influence its operation or effects under a fault condition. Consideration must be given to:

- Stored energy
- Supply disconnects
- Sequencing logic
- Unintended operation

650V Quick Start

- Mount the drive vertically in a lockable cubicle.
- Is the drive to operate in Local (using the keypad) or Remote Control? If Remote Control, make Control Connections.
- Make Power Connections. Power-on and follow the Quick Set-Up procedure.
- Apply a small setpoint. Start and stop the motor.

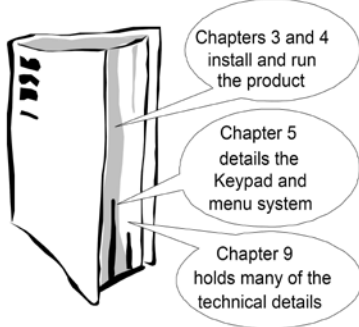
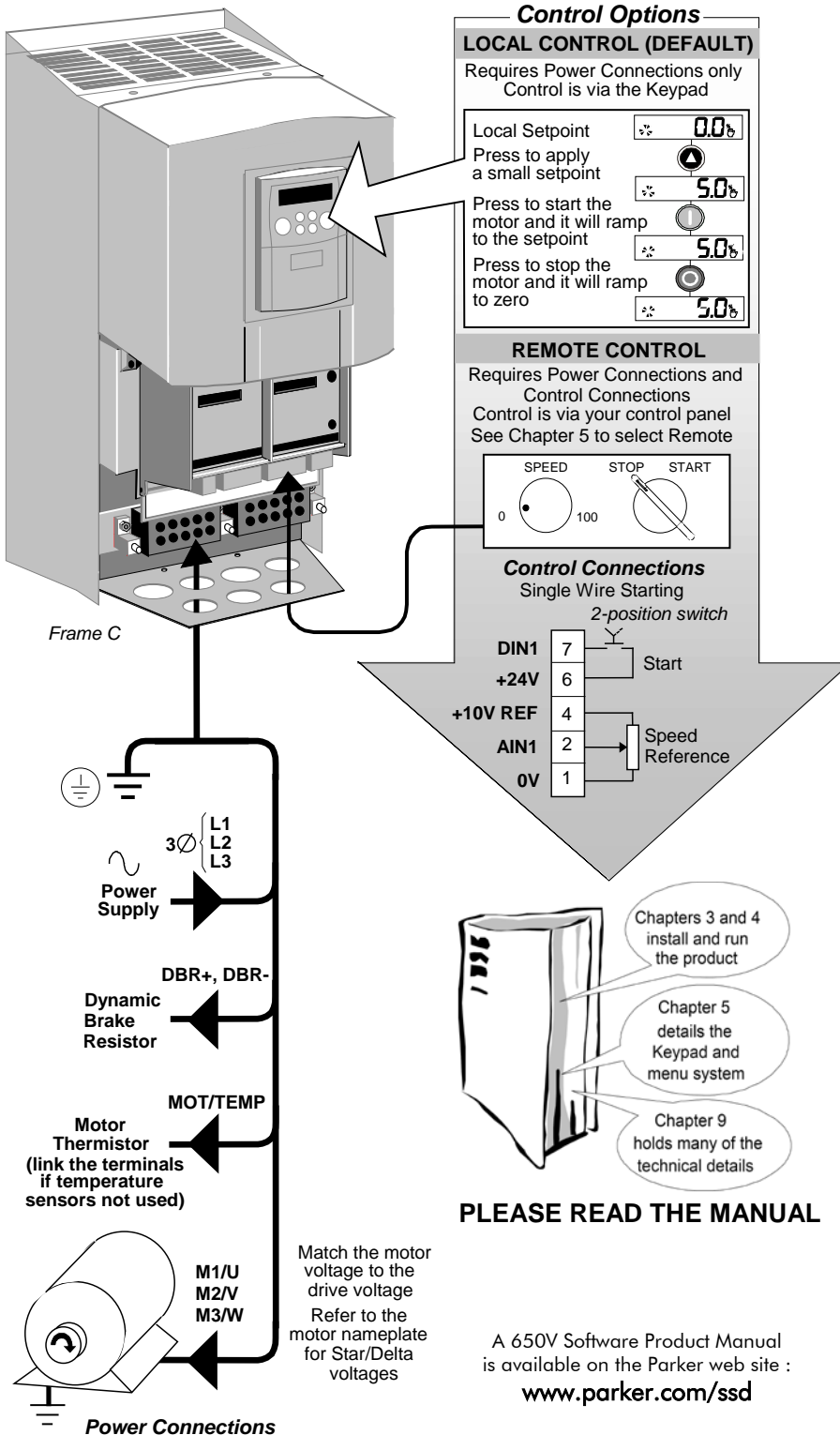

PLEASE READ THE MANUAL

A 650V Software Product Manual is available on the Parker web site : www.parker.com/ssd

Quick Set-Up

Hold the M key until DIAG is displayed

Navigate to the PAR menu

Press to enter the menu and see the first parameter

Press to show the next parameter

Press to edit the MAX SPEED parameter

Adjust MAX SPEED

Press to exit the parameter

Press (4 times) to show P6

Press to edit the MOTOR CURRENT parameter

Adjust MOTOR CURRENT Refer to motor nameplate

Press to exit the parameter

Press to show P7

Press to edit the BASE FREQUENCY parameter

Adjust BASE FREQUENCY

Press (3 times) to display the Local Setpoint

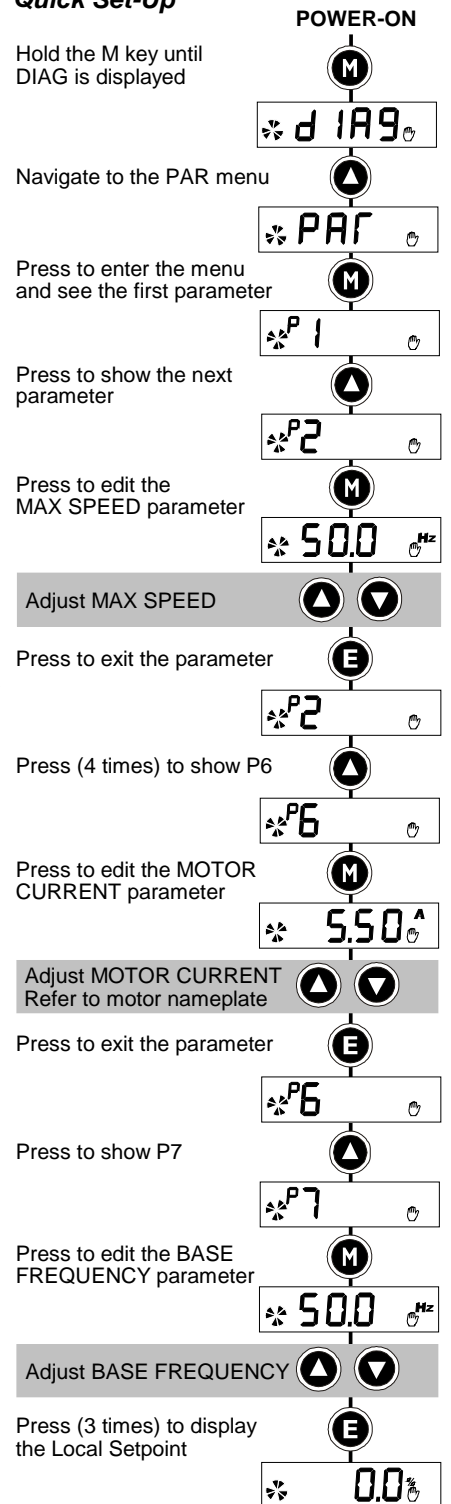

Contents

	<i>Contents</i>	<i>Page</i>
CHAPTER 1	GETTING STARTED	1-1
	Introduction	1-1
	Equipment Inspection	1-1
	Packaging and Lifting Details	1-1
	About this Manual	1-2
	Initial Steps	1-2
	How the Manual is Organised	1-2
CHAPTER 2	AN OVERVIEW OF THE DRIVE	2-1
	Component Identification	2-1
	Control Features	2-5
	Functional Overview	2-6
	Power Board/Stack	2-6
	Control Board	2-6
CHAPTER 3	INSTALLING THE DRIVE	3-1
	Mechanical Installation	3-1
	Mounting the Drive.....	3-1
	Ventilation	3-1
	Electrical Installation	3-11
	Gland Plate Details	3-11
	Cable Gland Requirements.....	3-11
	Wiring Instructions.....	3-12
	Terminal Block Acceptance Sizes	3-17
	Terminal Tightening Torques.....	3-17
	Optional Equipment.....	3-18
CHAPTER 4	OPERATING THE DRIVE	4-1
	Pre-Operation Checks	4-1
	Initial Start-up Routines	4-1
	Local Control Operation.....	4-2
	Remote Control Operation	4-2
	Set-up as an Open-loop Drive (V/F Fluxing)	4-3
	Set-up using the Sensorless Vector Fluxing Mode	4-4
	Reading the Status LEDs	4-6
CHAPTER 5	THE KEYPAD	5-1
	Using the Keypad	5-1
	Control Key Definitions	5-1
	Display Indications	5-2
	Drive Status Indications.....	5-2
	The Menu System.....	5-3
	How To Change a Parameter Value	5-4

Contents

<i>Contents</i>	<i>Page</i>
Special Menu Features.....	5-4
Resetting to Factory Defaults (2-button reset).....	5-4
Selecting Local or Remote Control.....	5-4
Password Protection	5-5
Quick Application Selection	5-5
CHAPTER 6 PROGRAMMING YOUR APPLICATION	6-1
MMI Parameters	6-1
The Diagnostics Menu	6-1
MMI Parameters Table.....	6-1
Product-Related Default Values	6-17
* Frequency Dependent Defaults	6-17
** Power Dependent Defaults.....	6-18
CHAPTER 7 TRIPS AND FAULT FINDING	7-1
Trips	7-1
Trip Warning Message	7-1
What Happens when a Trip Occurs.....	7-1
Resetting a Trip Condition.....	7-1
Using the Keypad to Manage Trips.....	7-1
Hexadecimal Representation of Trips.....	7-5
Fault Finding	7-6
CHAPTER 8 ROUTINE MAINTENANCE AND REPAIR	8-1
Routine Maintenance.....	8-1
Repair	8-1
Saving Your Application Data	8-1
Returning the Unit to Parker SSD Drives	8-1
Disposal	8-1
CHAPTER 9 TECHNICAL SPECIFICATIONS	9-1
Understanding the Product Code	9-1
Environmental Details.....	9-4
Earthing/Safety Details	9-4
Cabling Requirements for EMC Compliance	9-5
Cooling Fans	9-5
Electrical Ratings (230V Build Variant)	9-6
Electrical Ratings (400V Build Variant)	9-7
Input Fuse Ratings (Europe).....	9-10
External AC Supply (RFI) Filters.....	9-11
EMC Compliance.....	9-11
Internal Dynamic Brake Switch (Frame C)	9-12
Internal Dynamic Brake Switch (Frame D)	9-12
Internal Dynamic Brake Switch (Frame E).....	9-13
Internal Dynamic Brake Switch (Frame F).....	9-13
Analog Inputs/Outputs	9-14

Contents

<i>Contents</i>	<i>Page</i>	
Digital Inputs	9-14	
Relay	9-14	
Digital Outputs	9-14	
Supply Harmonic Analysis (Frame C Normal Duty).....	9-15	
Supply Harmonic Analysis (Frame C Heavy Duty).....	9-16	
Supply Harmonic Analysis (Frame D Normal Duty).....	9-17	
Supply Harmonic Analysis (Frame D Heavy Duty).....	9-18	
Supply Harmonic Analysis (Frame E Normal Duty)	9-19	
Supply Harmonic Analysis (Frame E Heavy Duty)	9-20	
Supply Harmonic Analysis (Frame F Normal Duty)	9-21	
Supply Harmonic Analysis (Frame F Heavy Duty).....	9-22	
CHAPTER 10	CERTIFICATION FOR THE DRIVE	10-1
Requirements for EMC Compliance.....	10-1	
Minimising Radiated Emissions	10-1	
Earthing Requirements.....	10-1	
Cabling Requirements	10-2	
EMC Installation Options.....	10-3	
Requirements for UL Compliance	10-6	
European Directives and the CE Mark.....	10-10	
CE Marking for Low Voltage Directive	10-10	
CE Marking for EMC - Who is Responsible?.....	10-10	
Which Standards Apply?.....	10-11	
Certificates.....	10-12	
CHAPTER 11	APPLICATION NOTES	11-1
Synchronous Motor Control	11-1	
Using Line Chokes	11-1	
Using Output Contactors.....	11-1	
Using Motor Chokes.....	11-1	
CHAPTER 12	SERIAL COMMUNICATIONS	12-1
Connection to the P3 Port	12-1	
CHAPTER 13	APPLICATIONS	13-1
The Default Application	13-1	
How to Load an Application	13-1	
Application Description	13-1	
Control Wiring for Applications.....	13-1	
Application 1 : Basic Speed Control (default)	13-2	
Application 2 : Auto/Manual Control	13-4	
Application 3 : Preset Speeds	13-6	
Application 4 : Raise/Lower Trim.....	13-8	
Application 5 : PID	13-10	

Introduction

The 650V, Frames C, D, E & F, is part of the 650 Series of AC Drives, designed for speed control of standard 3-phase induction motors. It is available in a range of ratings for heavy and normal torque applications. This dual mode feature provides a cost effective solution to general industrial applications, as well as the control of pumps and fans.

- The unit can be controlled remotely using configurable analogue and digital inputs and outputs, requiring no optional equipment.
- Controlling the unit locally using the 6521 (or 6901) keypad gives access to parameters, diagnostic messages, trip settings and full application programming a connection to a pc is required along with the drive software tool. Other features also become available, such as the advanced sensorless vector control scheme which gives high torque, low speed operation; selectable switching frequencies; and a unique Quiet Pattern control system that minimises audible noise from the motor.

The optional external RFI filters offer enhanced EMC compliance.

IMPORTANT: Motors used must be suitable for drive duty.

Note: *Do not attempt to control motors whose rated current is less than 50% of the drive rated current. Poor motor control or Autotune problems may occur if you do*

Equipment Inspection

- Check for signs of transit damage
- Check the product code on the rating label conforms to your requirement.

If the unit is not being installed immediately, store the unit in a well-ventilated place away from high temperatures, humidity, dust, or metal particles.

Refer to Chapter 2: “An Overview of the Drive” to check the rating label/product code.

Refer to Chapter 8: “Routine Maintenance and Repair” for information on returning damaged goods.

Packaging and Lifting Details

Caution

The packaging is combustible and, if disposed of in this manner incorrectly, may lead to the generation of lethal toxic fumes.

Save the packaging in case of return. Improper packaging can result in transit damage.

Use a safe and suitable lifting procedure when moving the drive. Never lift the drive by its terminal connections.

Prepare a clear, flat surface to receive the drive before attempting to move it. Do not damage any terminal connections when putting the drive down.

Refer to Chapter 3: “Installing the Drive” - Mechanical Installation for unit weights.

1-2 Getting Started

About this Manual

This manual is intended for use by the installer, user and programmer of the 650V drive. It assumes a reasonable level of understanding in these three disciplines.

Note: *Please read all Safety Information before proceeding with the installation and operation of this unit.*

Enter the “Model Number” from the rating label into the table at the front of this manual. It is important that you pass these manuals on to any new user of this unit.

Initial Steps

Use the manuals to help you plan the following:

Installation

Know your requirements:

- certification requirements, CE/UL/CUL conformance
- wall-mount or enclosure?
- conformance with local installation requirements
- supply and cabling requirements

Operation

Know your operator:

- how is it to be operated, local and/or remote?
- what level of user is going to operate the unit?

Programming (Keypad or suitable PC programming tool only)

Know your application:

- install the most appropriate Application
- plan your “block diagram programming”
- enter a password to guard against illicit or accidental changes
- customise the Keypad to the application

How the Manual is Organised

The manual is divided into chapters and paragraphs. Page numbering restarts with every chapter, i.e. 5-3 is Chapter 5, page 3.

Application Block Diagrams

You will find these at the rear of the manual. They will become your programming tool as you become more familiar with the 650V unit’s software.

Software Product Manual

An accompanying Software Product Manual is available for download from the Parker SSD Drives website: www.parker.com/ssd

Chapter 2 AN OVERVIEW OF THE DRIVE

Component Identification

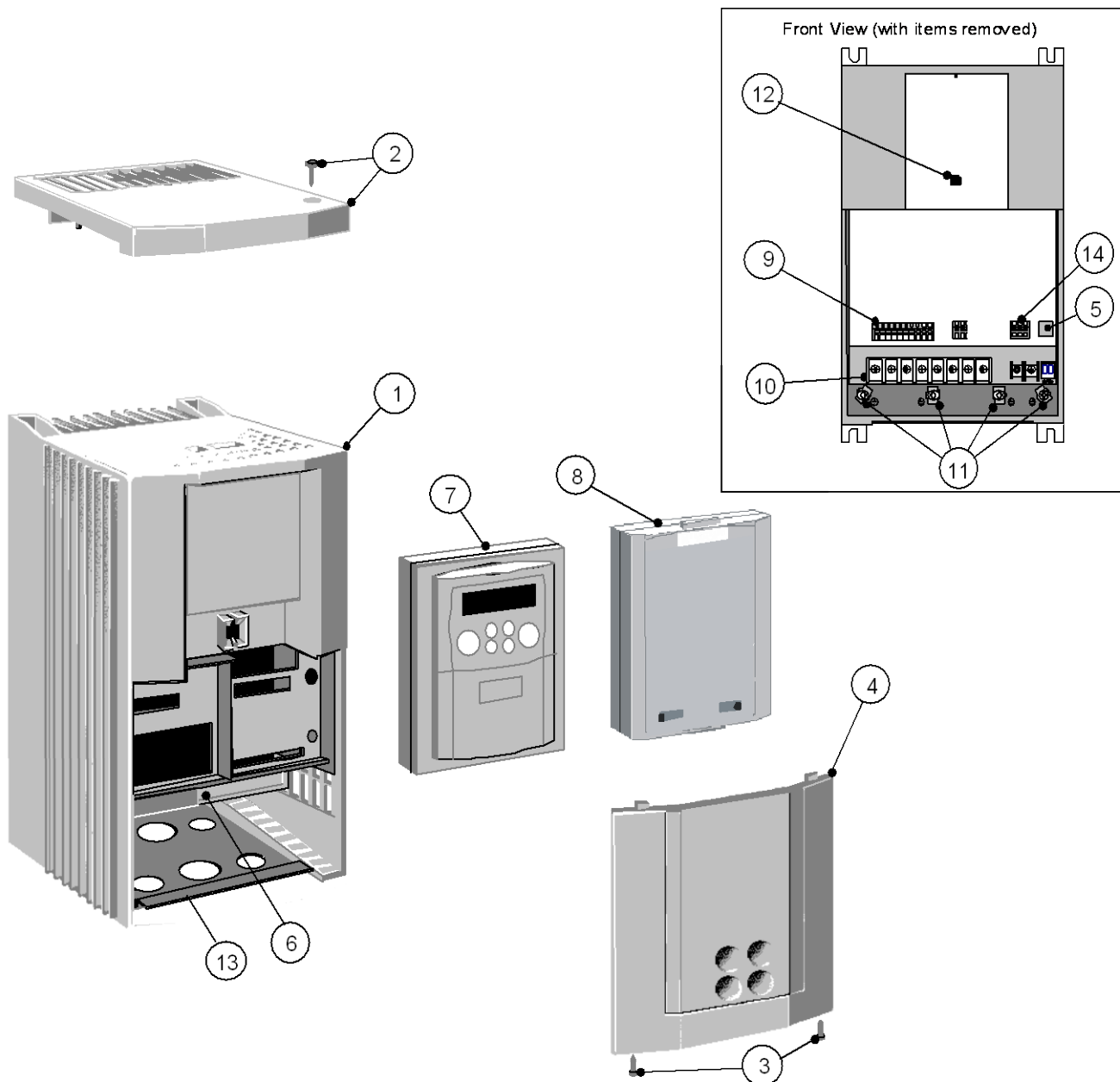

Figure 2-1 650V AC Drive, Frame C 11.0kW

1	Main drive assembly	8	Blank cover
2	Top cover (optional)	9	Control terminals
3	Terminal cover retaining screw	10	Power terminals
4	Terminal cover	11	Earthing points
5	RS232 programming port (P3)	12	Keypad port (P3)
6	Power terminal shield	13	Gland plate
7	6521 keypad (optional)	14	RS485 programming port (optional)

Through-panel fixing plate and screws not illustrated

2-2 An Overview of the Drive

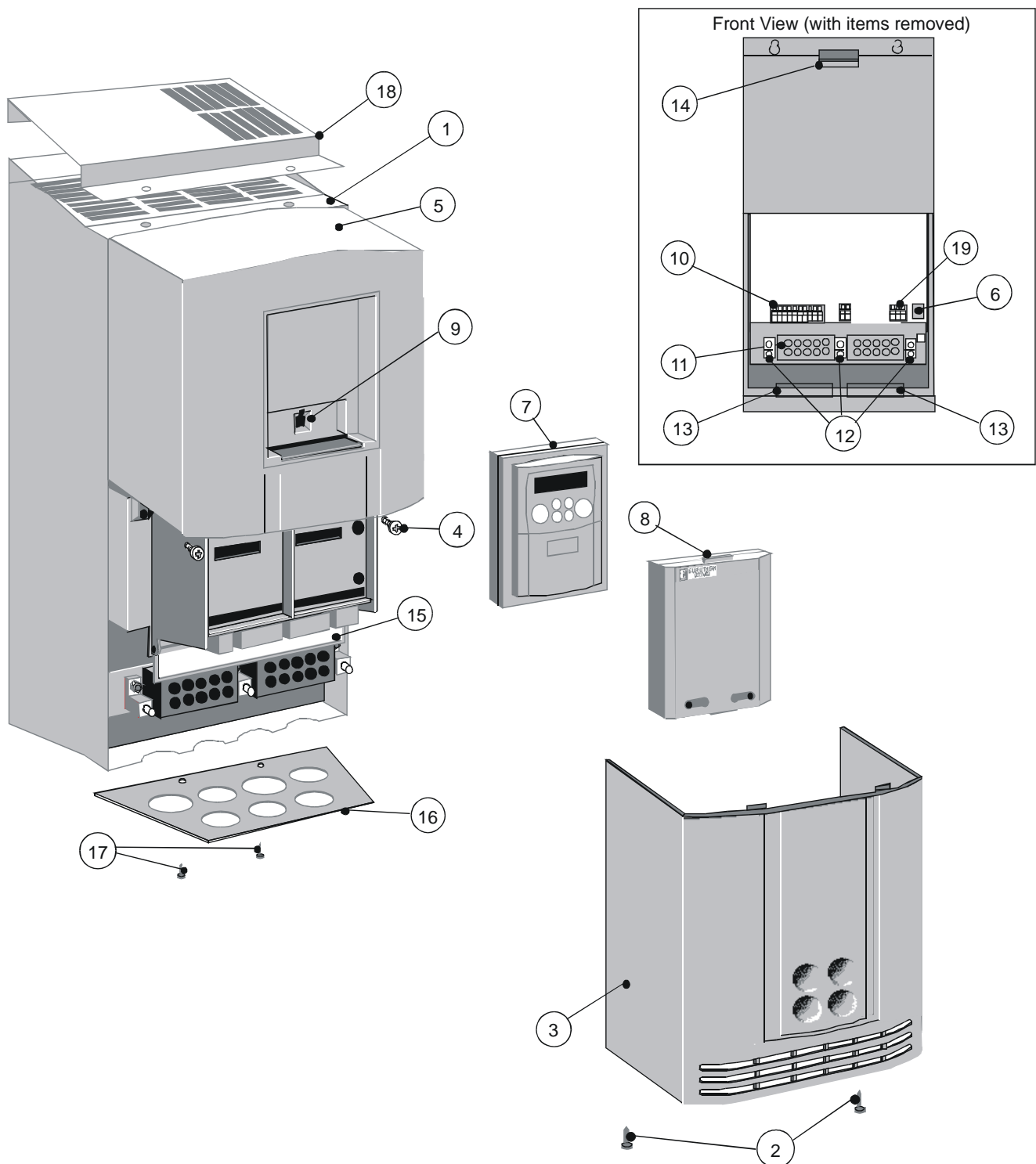

Figure 2-2 650V AC Drive, Frame D 15 - 22kW

1	Main drive assembly	10	Control terminals
2	Lower front cover retaining screw	11	Power terminals
3	Lower front cover	12	Earthing points
4	Upper front cover retaining screw	13	Chassis fan
5	Upper front cover	14	Power board fan
6	RS232 programming port (P3)	15	Power terminal shield
7	6521 keypad (optional)	16	Gland plate
8	Blank cover	17	Gland plate retaining screw
9	Keypad port (P3)	18	Top cover (optional)
		19	RS485 programming port (optional)

Through-panel fixing plate and screws not illustrated

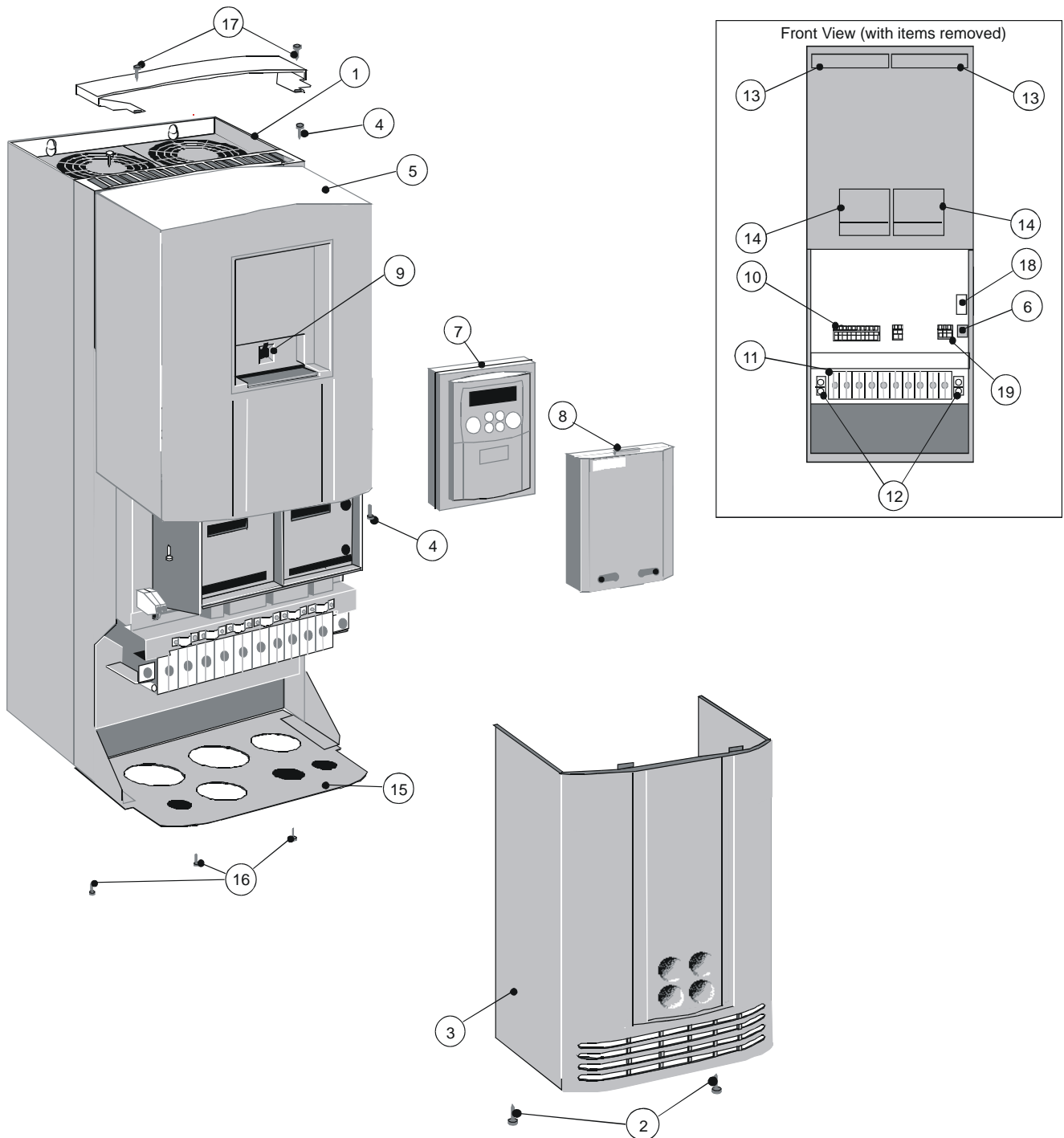

Figure 2-3 650V AC Drive, Frame E 30 - 45kW

- | | | | |
|----------|-----------------------------------|-----------|-----------------------------------|
| 1 | Main drive assembly | 10 | Control terminals |
| 2 | Lower front cover retaining screw | 11 | Power terminals |
| 3 | Lower front cover | 12 | Earthing points |
| 4 | Upper front cover retaining screw | 13 | Chassis fan |
| 5 | Upper front cover | 14 | Power board fan |
| 6 | RS232 programming port (P3) | 15 | Gland plate |
| 7 | 6521 keypad (optional) | 16 | Gland plate retaining screw |
| 8 | Blank cover | 17 | Top cover (optional) |
| 9 | Keypad port (P3) | 18 | Motor thermistor terminals |
| | | 19 | RS485 programming port (optional) |

Through-panel fixing plate and screws not illustrated

2-4 An Overview of the Drive

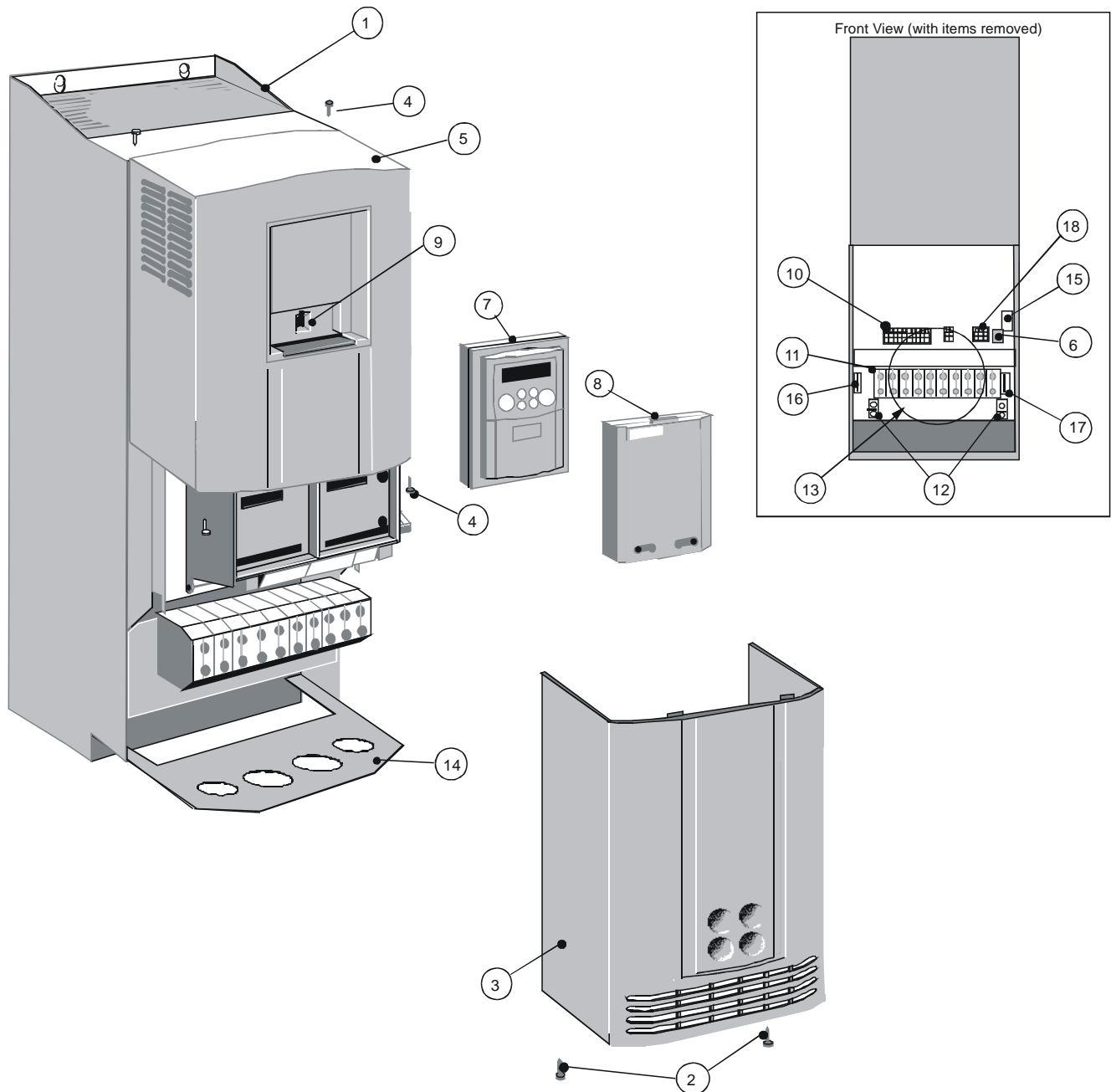

Figure 2-4 650V AC Drive, Frame F 55 - 90kW

1	Main drive assembly	10	Control terminals
2	Lower front cover retaining screw	11	Power terminals
3	Lower front cover	12	Earthing points
4	Upper front cover retaining screw	13	Chassis fan
5	Upper front cover	14	Gland plate
6	RS232 programming port (P3)	15	Motor thermistor terminals
7	6521 keypad (optional)	16	Auxiliary supply terminals (fan)
8	Blank cover	17	Brake terminals
9	Keypad port (P3)	18	RS485 programming port (optional)

Control Features

The drive is fully-featured when controlled using the optional Keypad (or a suitable PC programming tool).

DEFAULT

The 'General' control features below are not user-selectable when the unit is controlled using the analog and digital inputs and outputs.

General	Output Frequency	Selectable 0-240Hz
	Switching Frequency	3kHz nominal
	Voltage Boost	0-25%
	Flux Control	1. V/F control with linear or fan law profile 2. Sensorless vector with automatic flux control and slip compensation
	Skip Frequencies	2 skip frequencies with adjustable skip band width
	Preset Speeds	8 presets
	Stopping Modes	Ramp, coast, dc injection, fast stop
	S Ramp and Linear Ramp	Symmetric or asymmetric ramp up and down rates
	Raise/Lower	Programmable MOP function
	Jog	Programmable jog speed
	Logic Functions	10 programmable 3-input logic function blocks performing NOT, AND, NAND, OR, NOR and XOR functions, for example
Value Functions	10 programmable 3-input value function blocks performing IF, ABS, SWITCH, RATIO, ADD, SUB, TRACK/HOLD, and BINARY DECODE functions, for example	
Diagnostics	Full diagnostic and monitoring facilities	
Protection	Trip Conditions	Output short line to line, and line to earth Overcurrent > 200% Stall Heatsink overtemperature Motor Thermistor overtemperature Overvoltage and undervoltage
	Current Limit	Adjustable 110% or 150% 180% shock load limit Inverse Time
	Voltage/Frequency Profile	Constant torque Fan Law
Inputs/Outputs	Analog Inputs	2 inputs – one is configurable; voltage or current
	Analog Outputs	1 configurable voltage output
	Digital Inputs	6 configurable 24V dc inputs (2 suitable for encoder inputs)
	Digital I/O	1 configurable 24V dc open collector outputs/digital inputs
	Relay Outputs	1 configurable relay output

Table 2-1 Control Features

2-6 An Overview of the Drive

Functional Overview

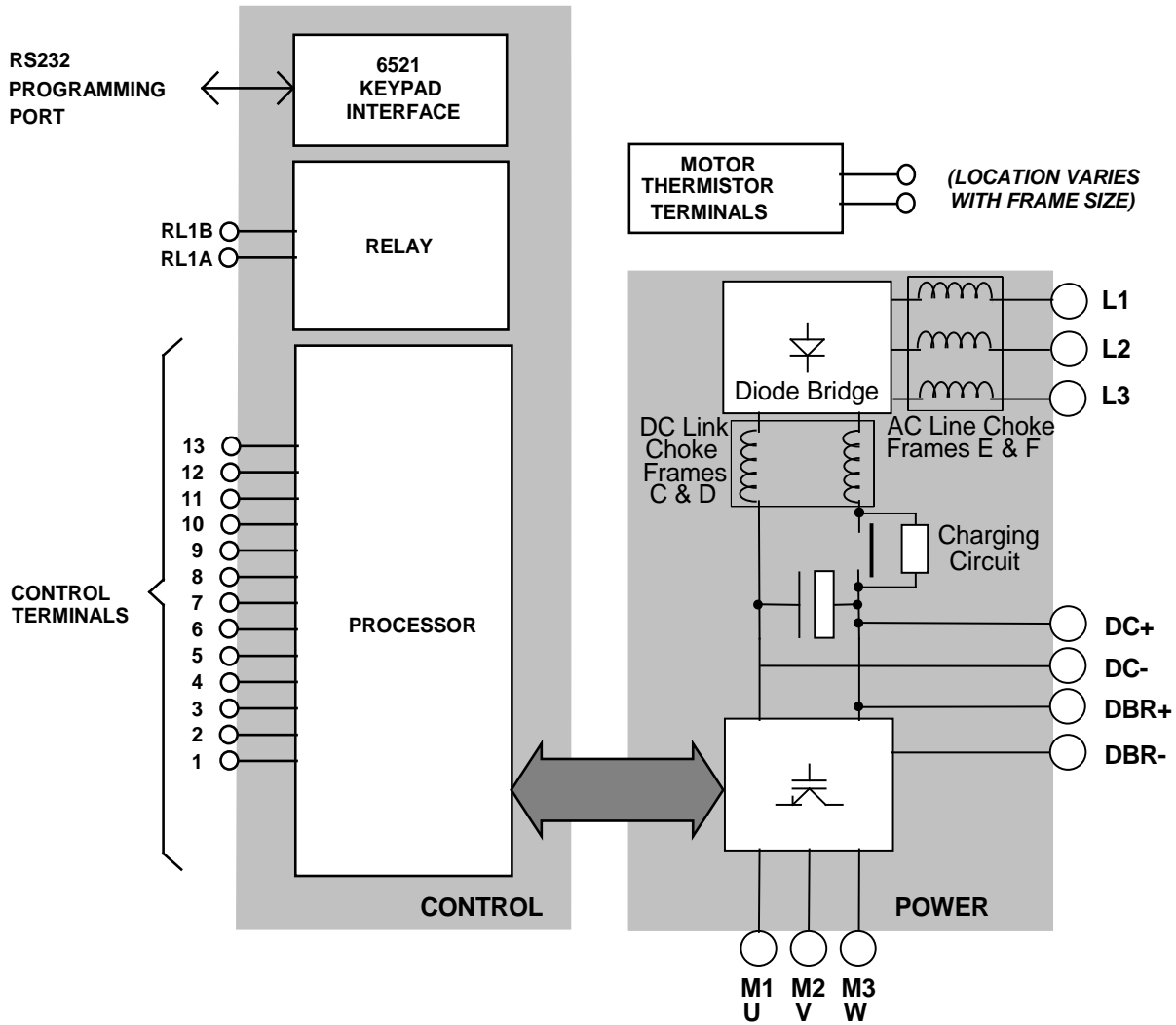

Figure 2-5 Functional Block Diagram (Frames C, D, E, F)

Power Board/Stack

DC link capacitors smooth the dc voltage output prior to the drive power stage. The IGBT (Insulated Gate Bi-polar Transistor) output stage converts the dc input to a three phase output used to drive the motor.

Control Board

Processor

The processor provides for a range of analog and digital inputs and outputs, together with their reference supplies. For further details refer to Chapter 9: "Technical Specifications" - Control Terminals.

Keypad Interface

This is a non-isolated RS232 serial link for communication with the Keypad. Alternatively, a PC running Parker SSD Drives' "DSE Lite" windows-based configuration software (or some other suitable PC programming tool) can be used to graphically program and configure the drive.

Chapter 3

INSTALLING THE DRIVE

IMPORTANT: Read Chapter 9: "Certification for the Drive" before installing this unit.

Mechanical Installation

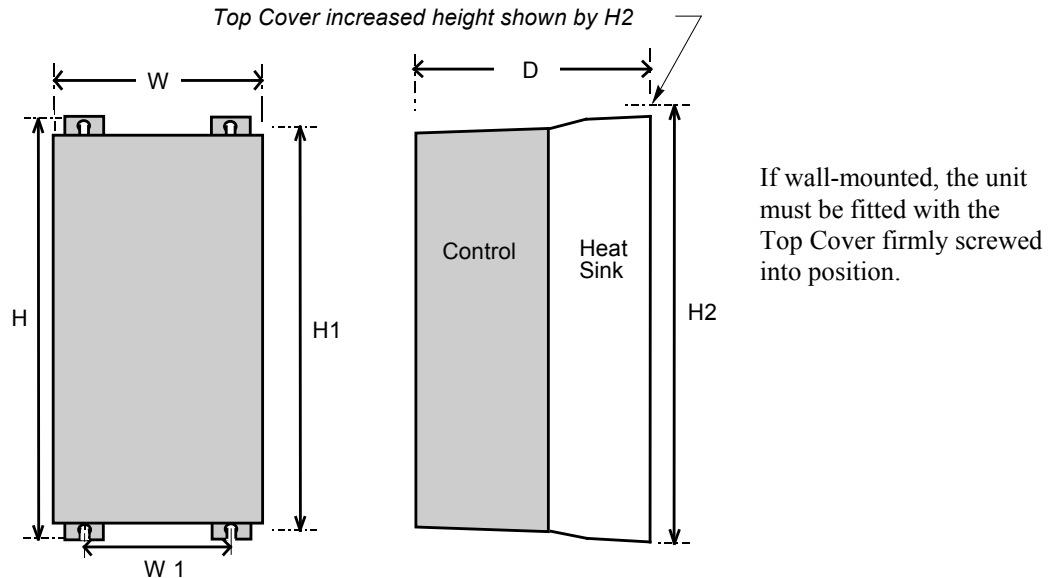

Approximate Frame C shown for illustration purposes

Figure Chapter 3 -1 Mechanical Dimensions for 650V Drives

Models	Max. Weight kg/lbs	H	H1	H2	W	W1	D	Fixings
Frame C	9.3/20.5	348.0 (13.70)	335.0 (13.19)	365.0 (14.37)	201.0 (7.91)	150 (5.90)	208.0 (8.19)	Slot 7mm wide Use M5 or M6 fixings.
Frame D	17.4/38.2	453.0 (17.8)	440.0 (17.3)	471.0 (18.5)	252.0 (9.92)	150 (5.90)	245.0 (9.65)	Slot 7mm wide Use M5 or M6 fixings.
Frame E	32.5/72	668.6 (26.3)	630.0 (24.8)	676.0 (26.6)	257.0 (10.1)	150.0 (5.9)	312 (12.3)	Use M6 fixings
Frame F	41/90.4	720.0 (28.3)	700.0 (27.6)	Not applicable	257.0 (10.1)	150.0 (5.9)	355.0 (14.0)	Use M6 fixings
All dimensions are in millimetres (inches)								

Note: For details of a through-panel mounting option for Frames D & E refer to pages 3-5 and 3-7 respectively.

Mounting the Drive

The unit must be mounted vertically on a solid, flat, vertical surface. It can be wall-mounted, or mounted inside a suitable cubicle, depending upon the required level of EMC compliance - refer to Chapter 9: "Technical Specifications".

Ventilation

The drive gives off heat in normal operation and must therefore be mounted to allow the free flow of air through the ventilation slots and heatsink. Maintain minimum clearances for ventilation as given in the tables below to ensure adequate cooling of the drive, and that heat generated by other adjacent equipment is not transmitted to the drive. Be aware that other equipment may have its own clearance requirements. When mounting two or more 650V units together, these clearances are additive. Ensure that the mounting surface is normally cool.

3-2 Installing the Drive

Minimum Air Clearance (Frame C)

Cubicle-Mount Product/Application (Frame C)

(Europe: IP2x, USA/Canada: Open Type).

The drive, without the top cover fitted, must be mounted in a suitable cubicle.

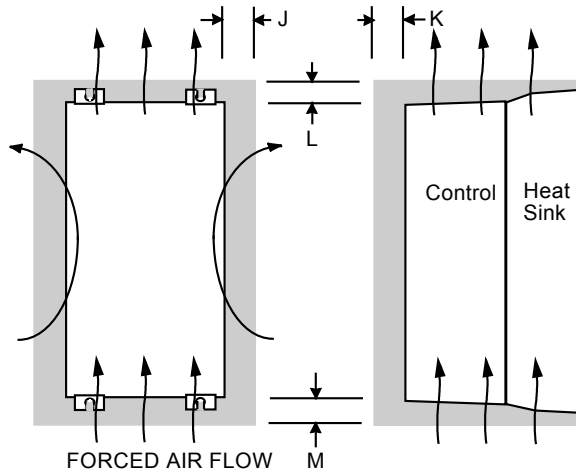

Figure Chapter 3 -2 Air Clearance for a Cubicle-Mount Product/Application

Model Recognition	Clearances for Standard Product without Top Cover (mm)			
	J	K	L	M
Frame C	15	15	70	70

Wall-Mount Product/Application (Frame C)

(Europe: IP2x plus IP4x top surface protection, USA/Canada: Type 1).

Wall-mounted 650V units **must** have the top cover correctly fitted. The top cover fixing screw has a maximum tightening torque of 1.5Nm (1.2Nm recommended).

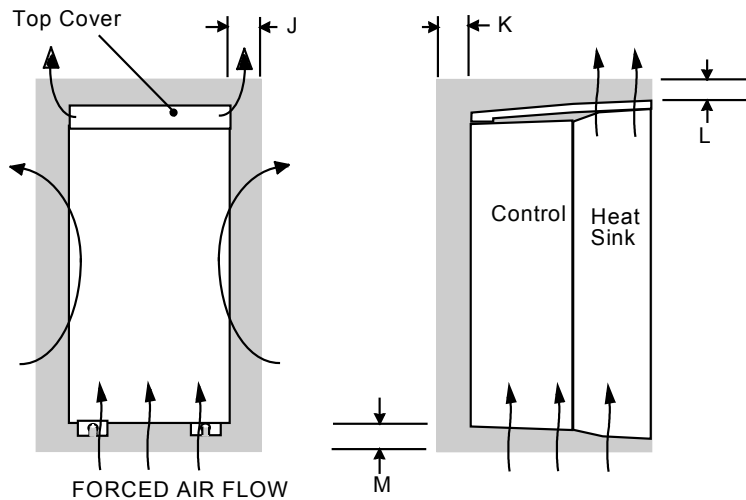

Figure Chapter 3 -3 Air Clearance for a Wall-Mount Product/Application

Model Recognition	Clearances for Standard Product fitted with Top Cover (mm)			
	J	K	L	M
Frame C	20	15	70	70

Through-Panel Mount Product/Application (Frame C)

(Europe: IP2x, USA/Canada: Open Type).

The drive, without the top cover fitted, can be mounted in a suitable cubicle.

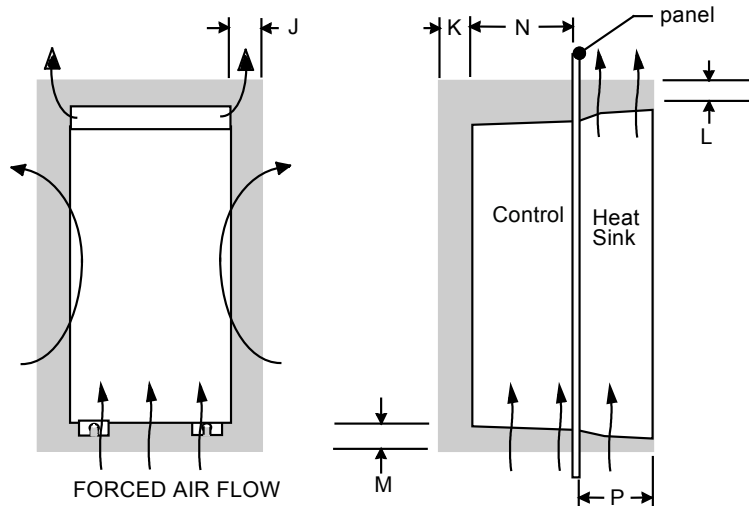

Figure Chapter 3 -4 Air Clearance for a Through-Panel Mount Product/Application

Model Recognition	Clearances for Through-Panel Mount Standard Product (mm)				Through-Panel Dimensions	
	J	K	L	M	N	P
Frame C	20	15	70	70		

Through-Panel Mount Bracket Assembly (Frame C)

The through-panel kit is available as a separate item, part number LA465034U003.

Through-panel mounting a drive in a cubicle allows you to use a smaller cubicle because much of the heat generated by the drive is dissipated outside the cubicle.

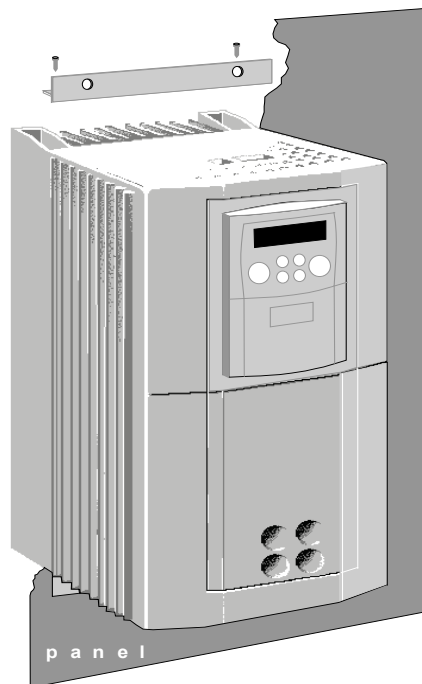

- Cut the panel aperture to the dimensions given in the drawing at the end of this chapter.
- Screw the top and bottom brackets to the drive as shown, torque to 3Nm. When in position, these complete a mating face for the panel around the drive.
- Fit the top and bottom self-adhesive gasket material to the brackets making sure that the gasket covers the gap between the bracket and heatsink along the top and bottom edge of the drive.
- Fit a gasket to each side of the drive to complete the gasket seal. Ensure a complete seal is made; 2 extra side gaskets are provided.
- Offer up the drive to the panel and secure.

Refer to Through-Panel Cutout Details, page 3-9.

3-4 Installing the Drive

Minimum Air Clearance (Frame D)

Cubicle-Mount Product/Application (Frame D)

(Europe: IP2x, USA/Canada: Open Type).

The drive, without the top cover fitted, must be mounted in a suitable cubicle.

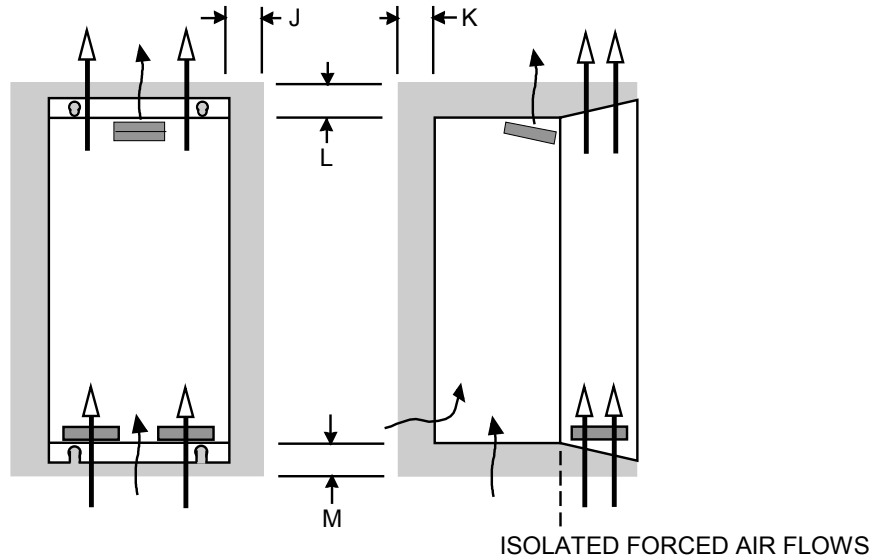

Figure Chapter 3-5 Air Clearance for a Cubicle-Mount Product/Application

Model Recognition	Clearances for Standard Product without Top Cover (mm)			
	J	K	L	M
Frame D	15 LHS, 5 RHS	25	70	70

Wall-Mount Product/Application (Frame D)

(Europe: IP2x plus IP4x top surface protection, USA/Canada: Type 1).

Wall-mounted 650V units **must** have the top cover correctly fitted. The top cover fixing screw has a maximum tightening torque of 1.5Nm (1.2Nm recommended).

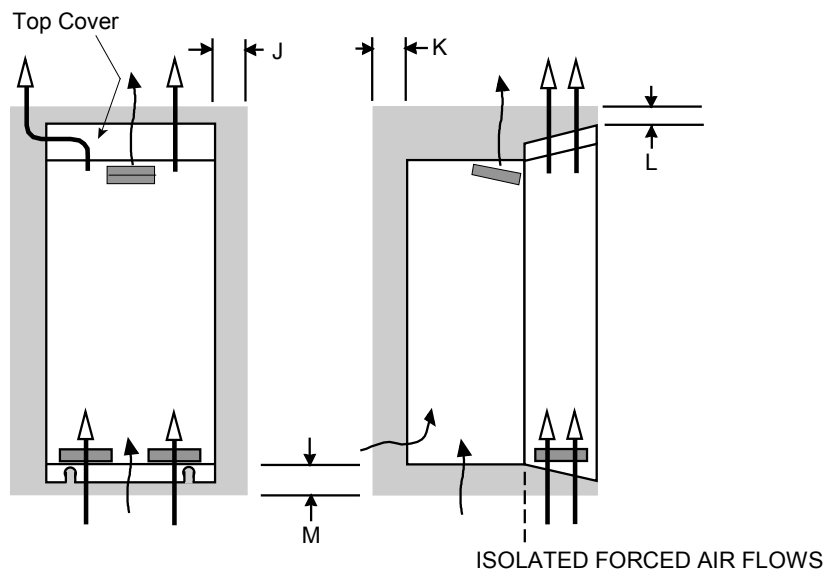

Figure Chapter 3-6 Air Clearance for a Wall-Mount Product/Application

Model Recognition	Clearances for Standard Product fitted with Top Cover (mm)			
	J	K	L	M
Frame D	15 LHS, 5 RHS	25	70	70

Through-Panel Mount Product/Application (Frame D)

(Europe: IP2x, USA/Canada: Open Type).

The drive, without the top cover fitted, can be mounted in a suitable cubicle.

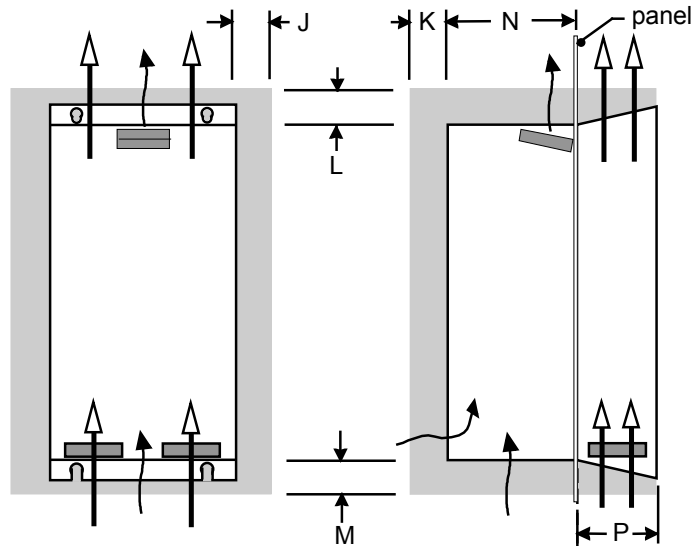

ISOLATED FORCED AIR FLOWS

Figure Chapter 3 -7 Air Clearance for a Through-Panel Mount Product/Application

Model Recognition	Clearances for Through-Panel Mount Standard Product (mm)				Through-Panel Dimensions	
	J	K	L	M	N	P
Frame D	15 LHS, 5 RHS	25	100	100	141	104



Through-Panel Mount Bracket Assembly (Frame D)

The through-panel kit is available as a separate item, part number LA465048U003.

Through-panel mounting a drive in a cubicle allows you to use a smaller cubicle because much of the heat generated by the drive is dissipated outside the cubicle.

- Cut the panel aperture to the dimensions given in the drawing at the end of this chapter.
- Screw the top and bottom brackets to the drive as shown, torque to 4Nm. When in position, these complete a mating face for the panel around the drive.
- Fit the top and bottom gaskets to the panel, aligning the gasket holes with the holes in the panel for fixing the drive. Fit two side gaskets around the panel aperture so that an air-tight seal will be made between the drive and the panel; 2 extra side gaskets are provided.
- Offer up the drive to the panel and secure.

Refer to Through-Panel Cutout Details, page 3-8.

3-6 Installing the Drive

Minimum Air Clearance (Frame E)

Cubicle-Mount Product/Application (Frame E)

(Europe: IP2x, USA/Canada: Open Type).

The drive, without the top cover fitted, must be mounted in a suitable cubicle.

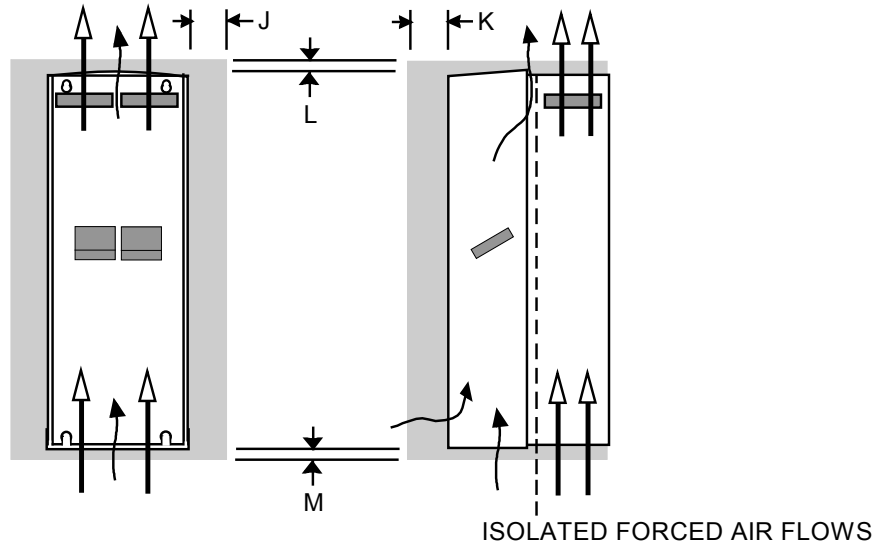

Figure Chapter 3-8 Air Clearance for a Cubicle-Mount Product/Application

Model Recognition	Clearances for Standard Product without Top Cover (mm)			
	J	K	L	M
Frame E	0 (zero)	25	70	70

Wall-Mount Product/Application (Frame E)

(Europe: IP2x plus IP4x top surface protection, USA/Canada: Type 1).

Wall-mounted 650V units **must** have the top cover correctly fitted. The top cover fixing screw has a maximum tightening torque of 1.5Nm (1.2Nm recommended).

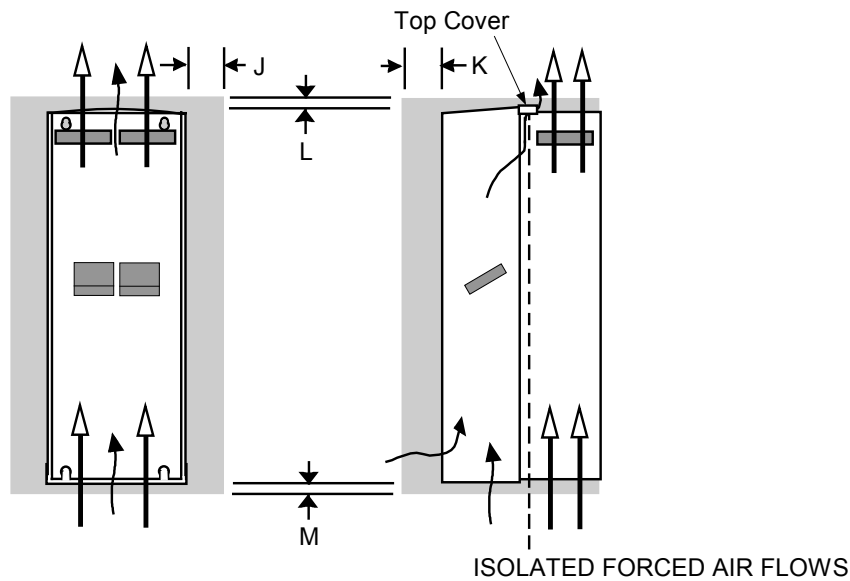

Figure Chapter 3-9 Air Clearance for a Wall-Mount Product/Application

Model Recognition	Clearances for Standard Product fitted with Top Cover (mm)			
	J	K	L	M
Frame E	0 (zero)	25	70	70

Through-Panel Mount Product/Application (Frame E)

(Europe: IP2x, USA/Canada: Open Type).

The drive, without the top cover fitted, can be through-panel mounted in a suitable cubicle.

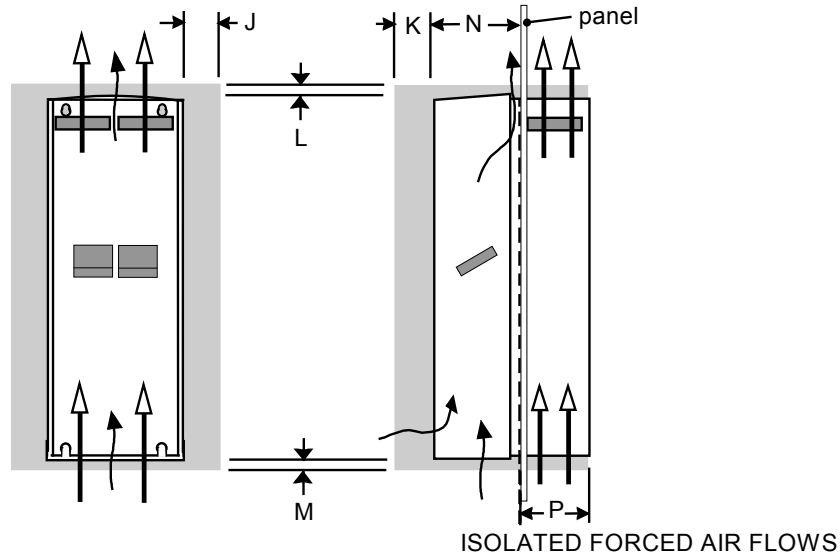
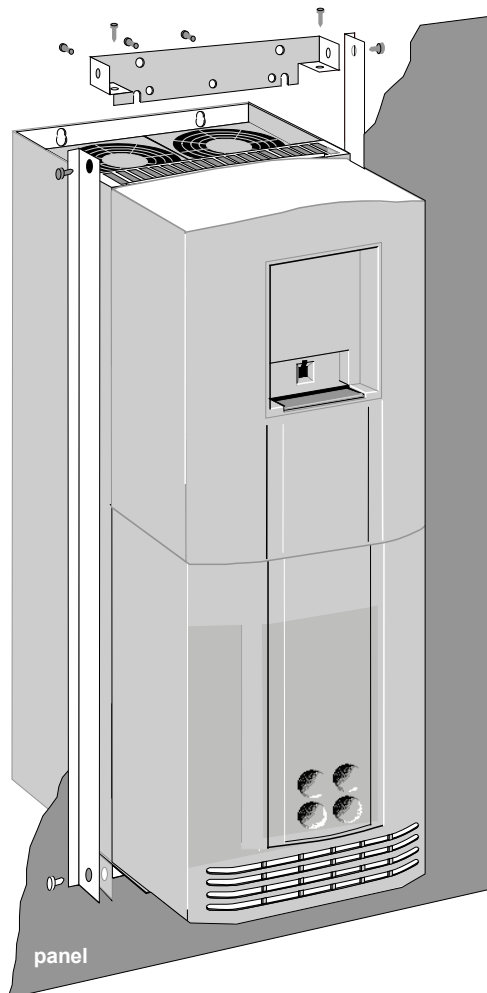

Figure Chapter 3 -10 Air Clearance for a Through-Panel Mount Product/Application

Model Recognition	Clearances for Through-Panel Mount Standard Product (mm)				Through-Panel Dimensions	
	J	K	L	M	N	P
Frame E	0 (zero)	25	70	70	180	129 (panel thickness not included, max. thickness 5mm)



Through-Panel Mount Bracket Assembly (Frame E)

The through-panel kit is available as a separate item, part number LA465058U003.

Through-panel mounting a drive in a cubicle allows you to use a smaller cubicle because much of the heat generated by the drive is dissipated outside the cubicle.

- Cut the panel aperture to the dimensions given in the drawing at the end of this chapter.
- Lay the drive on its back.
- Lightly screw the top and bottom brackets to the drive as shown.
- Fit the two side brackets to complete the frame and tighten all screws securely.
- Fit the self-adhesive gasket material to the mating face of the drive to produce an air-tight seal between the drive and the panel.
- Offer up the drive to the panel and secure.

Refer to Through-Panel Cutout Details, page 3-8.

3-8 Installing the Drive

Through-Panel Cutout Details

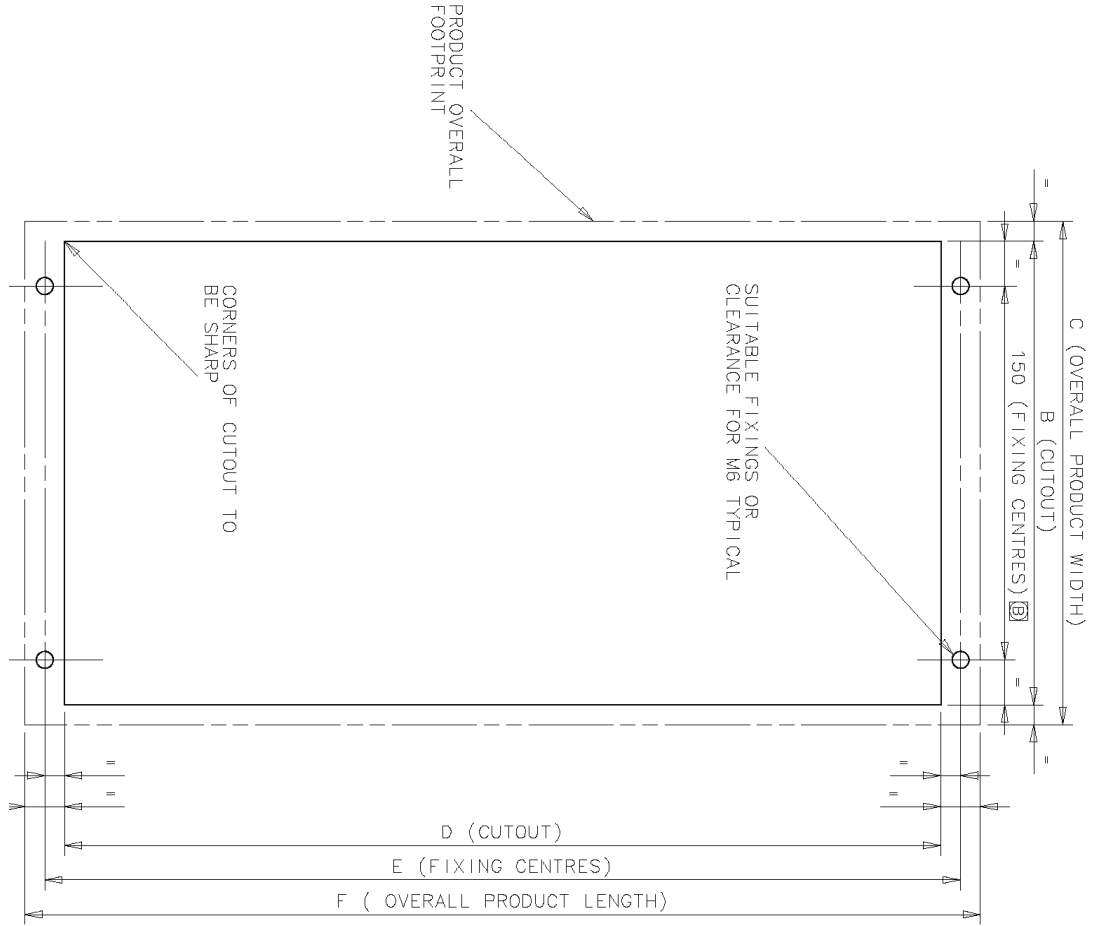

PRODUCT	DIM "B"	DIM "C"	DIM "D"	DIM "E"	DIM "F"
FRAME C	186	196	354	370	390
FRAME D	236	252	453	470	485
FRAME E	255	290	649	667.5	687

Minimum Air Clearance (Frame F)

Note: There is no through panel-mount capability for the 650V Frame F.

Cubicle-Mount Product/Application (Frame F)

(Europe: IP2x, USA/Canada: Open Type).

The drive must be mounted in a suitable cubicle.

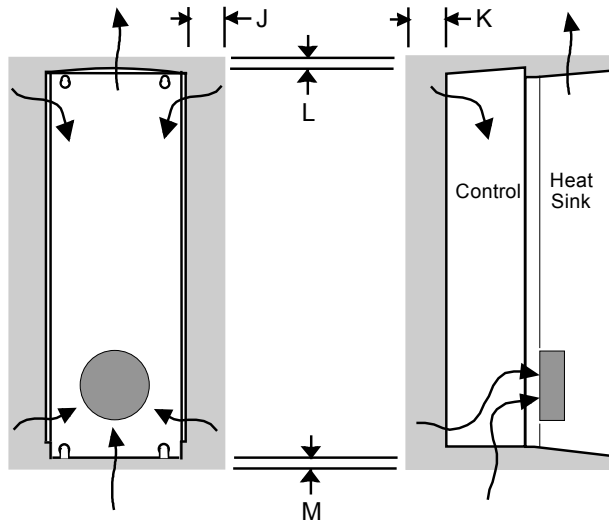

Figure Chapter 3 -11 Air Clearance for a Cubicle-Mount Product/Application

Model Recognition	Clearances for Standard Product (mm)			
	J	K	L	M
Frame F	0 (zero)	25	70	70

Duct Kit

A Duct kit, Part Number LA466717U003 is available for the 650V Frame F drive.

The installation diagram is provided on the following page.

Caution

Protect any equipment in the cubicle from swarf etc.
 Ensure all equipment is isolated.

- ◆ The duct length determines the vertical position of the drive in the cubicle. Drill the lower mounting panel hole centres for the drive at 976mm from the top of the cubicle. There is a generous tolerance of ± 4 mm.
- ◆ Cut-out the hole for the duct directly above where the drive sits. Project the position of the drive mounting surface inside the cubicle and mark it on the roof. From the drawing, you can calculate that the cut-out is made 8.5mm in front of the drive mounting surface (the centres for the cowling fixing holes will be 7.5mm behind the drive mounting surface). Draw the cut-out shape, check its position, and cut it out.
- ◆ Because of the weight of the drive, it may be better to secure the drive in the cubicle first, and lower the duct into the cubicle from above.
- ◆ Fix the duct to the drive using the M4 fasteners.
- ◆ Fit the gasket between the duct cowling and the top of the cubicle to provide a good seal. Drill through and secure all this with the M6 fasteners.

3-10 Installing the Drive

Duct Kit Installation Diagram

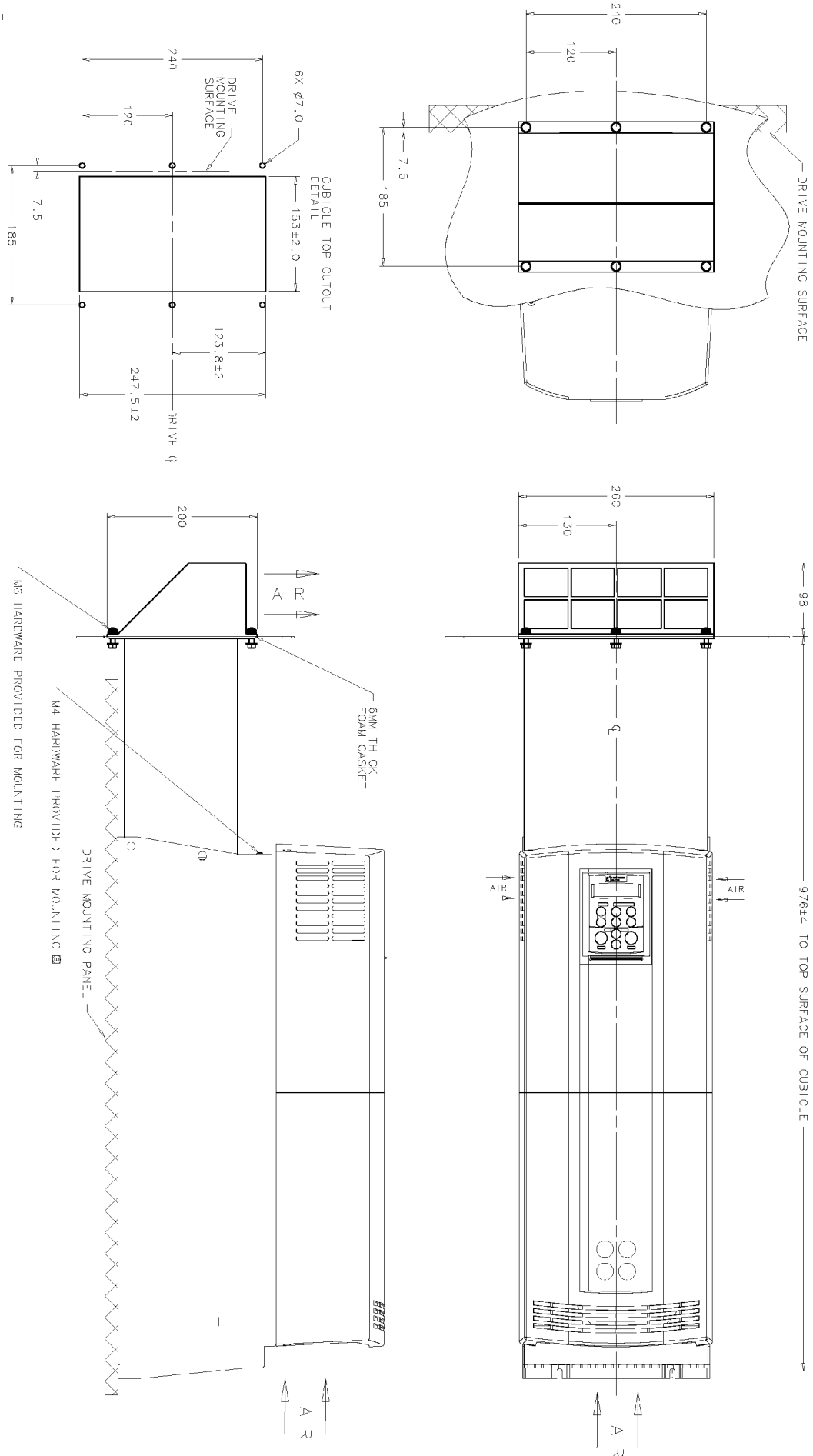

Electrical Installation

IMPORTANT: Please read the Safety Information on page Cont. 3 & 4 before proceeding.

WARNING!

This product is designated as "professional equipment" as defined in EN61000-3-2. Where enforced, permission of the supply authority shall be obtained before connection to the low voltage domestic supply. Ensure that all wiring is electrically isolated and cannot be made "live" unintentionally by other personnel. The drive is only suitable for use with earth referenced supplies (TN) when fitted with an internal ac supply EMC filter.

Note: Refer to Chapter 9: "Technical Specifications" for additional Cabling Requirements and Terminal Block Wire Sizes.

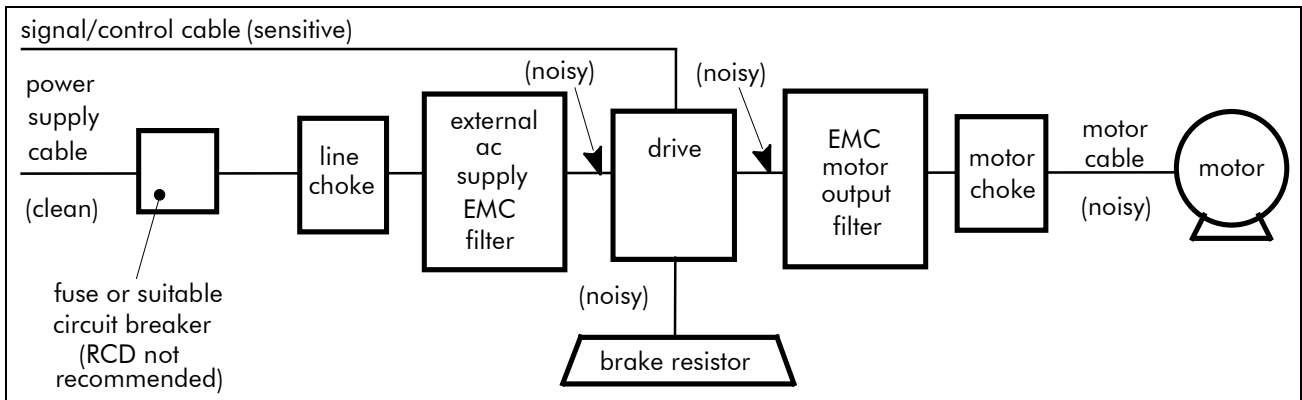

Figure Chapter 3 -12 Cabling Requirements

Cables are considered to be electrically *sensitive*, *clean* or *noisy*. You should already have planned your cable routes with respect to segregating these cables for EMC compliance. If not, refer to Chapter 10: "Certification for the Drive".

Gland Plate Details

- Frame C** The gland plate holes accept the following gland sizes:
- 22.8mm to accept metric M20, PG16 and American 1/2" NPT cable gland sizes
 - 28.6mm to accept M25, PG21 and American 3/4" NPT cable gland sizes
- Frame D** The gland plate holes accept the following gland sizes:
- 28.6mm to accept metric M20, PG16 and American 1/2" NPT cable gland sizes
 - 37.3mm to accept metric M32, PG29 and American 1" NPT
- Frame E** The gland plate holes accept the following gland sizes:
- 22.8mm to accept metric M20, PG16 and American 1/2" NPT cable gland sizes
 - 28.6mm to accept metric M25, PG21 and American 3/4" NPT cable gland sizes
 - 47.3mm to accept metric M40, PG36 and American 1 1/4" NPT cable gland sizes
 - 54.3mm to accept metric M50, PG42 and American 1 1/2" NPT cable gland sizes
- Frame F** The gland plate holes accept the following gland sizes:
- 22.8mm to accept metric M20, PG16 and American 1/2" NPT cable gland sizes
 - 28.6mm to accept M25, PG21 and American 3/4" NPT cable gland sizes

Cable Gland Requirements

Use a metal gland to connect to the internally earthed gland plate. It must be capable of securing a 360 degree screened connection to give EMC compliance.

A 360 degree screened connection can be achieved as shown.

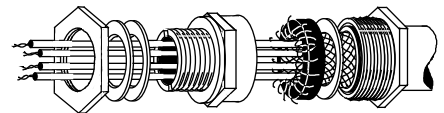

Figure Chapter 3 -13 360 Degree Screened Connection

3-12 Installing the Drive

Wiring Instructions

Local Control Wiring

This is the simplest installation. Every new drive will operate in Local Control when first powered-up. The keypad is used to start and stop the drive.

Refer to the appropriate Power Wiring Connections diagram and install the:

- Thermistor cable, or link/jumper terminals TH1A and TH1B if not used (we recommend you use a thermistor)
(we recommend you do use a thermistor)
- Motor cable
- Supply cable
- Follow the earthing/grounding and screening advice

Refer to Chapter 4: "Operating the Drive"- Local Control Operation.

Minimum Connections

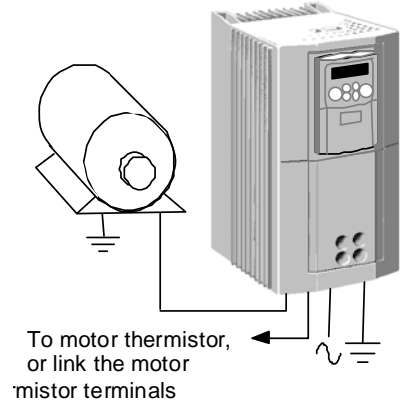

Remote Control Wiring

If operating in Remote Control you will use your control panel to start and stop the drive, via a speed potentiometer and switches or push-buttons.

Your wiring of the control terminals will be governed by the Application you use: refer to Chapter 13 for an explanation of the various Applications you can select and the appropriate control wiring. Application 1 is the default Application.

The diagram below shows the **minimum** connections to operate the drive for single-wire starting (switch), and push-button starting. Other control connections for your Application, shown in Chapter 13, can be made to suit your system.

Minimum Connections for Application 1: Single Wire Starting

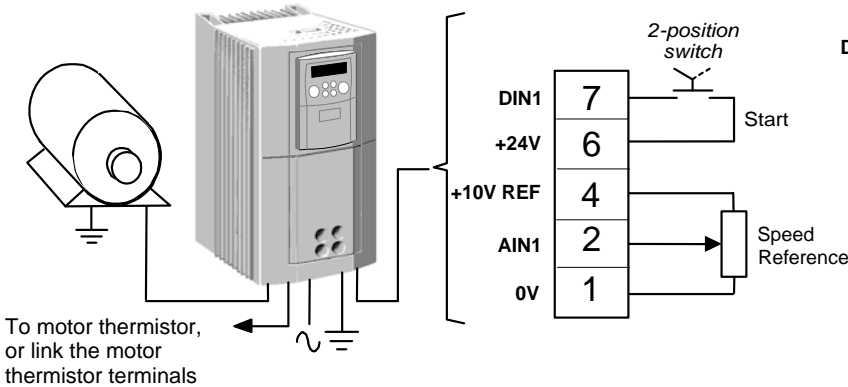

Push-Button Starting

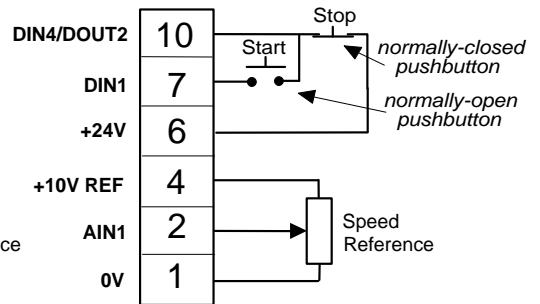

Note: Use screened control cables to comply with EMC requirements. All screens terminated using a gland at the gland plate.

1. Install as above, for Local Control Wiring
2. Refer to Chapter 13 and install control wiring for your system
3. Feed the control cables into the drive through the metal gland plate and connect to the control terminals.
4. The bank of cables (1-10) **must** be secured together with a cable tie as close to the terminals as possible.
5. Refit and secure the terminal cover using the retaining screws.

IMPORTANT: The control board 0V must be connected to protective earth outside of the product to meet EMC and safety requirements.

Note: You can still operate the drive in Local mode, if necessary, with any Application selected.

Refer to Chapter 4: "Operating the Drive" and follow the relevant instructions for Single Wire Starting or Push-Button Starting.

Power Wiring Connections

Protective Earth (PE) Connections

The unit must be **permanently earthed** according to EN 50178 - see below. Protect the incoming mains supply using a suitable fuse or circuit breaker (circuit breaker types RCD, ELCB, GFCI are not recommended). Refer to "Earth Fault Monitoring Systems", page 3-25.

IMPORTANT: The drive is only suitable for earth referenced supplies (TN) when fitted with an internal filter. External filters are available for use on TN and IT (non-earth referenced) supplies.

For installations to EN 50178 in Europe:

- for permanent earthing, two individual incoming protective earth conductors (<math><10\text{mm}^2</math> cross-section) or one conductor (>math>>10\text{mm}^2</math> cross-section) are required. Each earth conductor must be suitable for the fault current according to EN 60204.

Refer to Chapter 10: "Certification for the Drive" - EMC Installation Options.

Motor Connections

1 metal cable gland

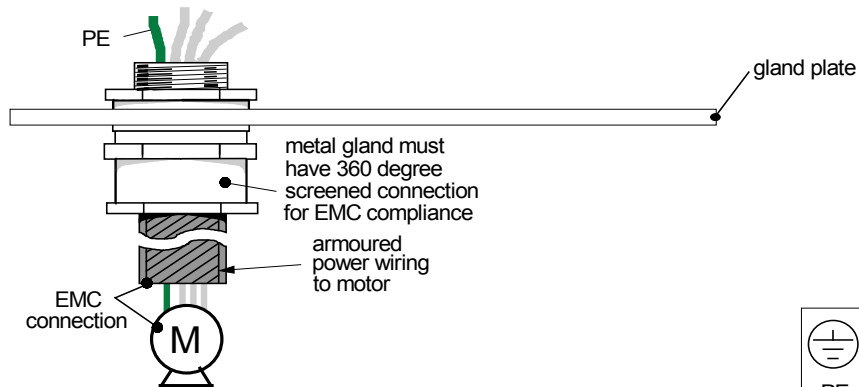

2 standard fitment rubber grommet (non-EMC compliant)

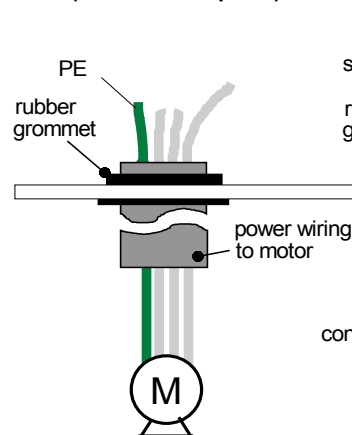

3 earth clamp connection (Frame C only)

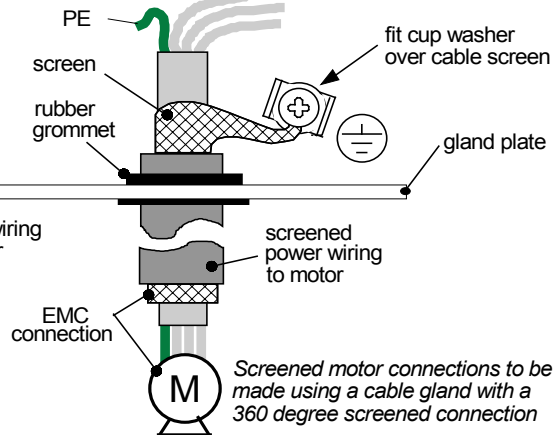

3-14 Installing the Drive

Power Wiring Connections (Frame C)

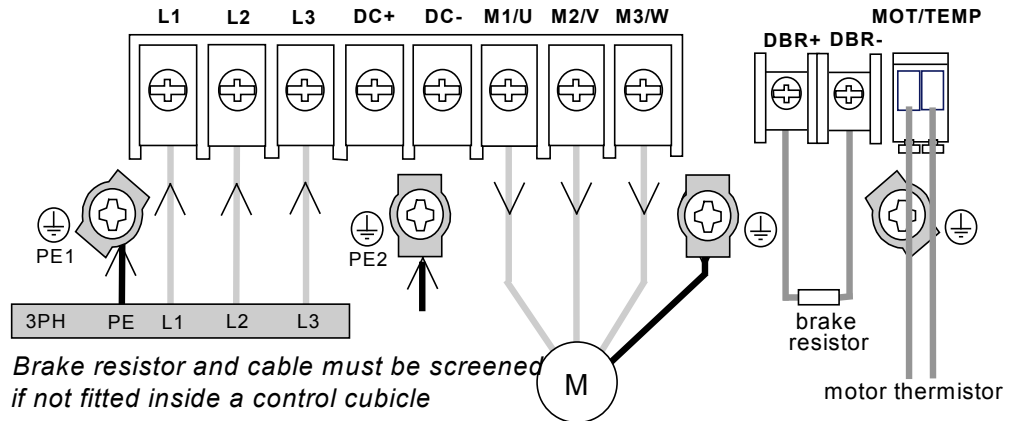

Brake resistor and cable must be screened if not fitted inside a control cubicle

All screens terminated using a gland at the gland plate

1. Remove the terminal cover retaining screws and lift off the terminal cover.
2. Lift the internal power terminal shield.
3. Feed the power supply and motor cables into the drive through the metal gland plate using the correct cable entries, and connect to the power terminals. Tighten all terminals to the correct tightening torque, refer to the Terminal Tightening Torques table. Lower the internal power terminal shield.

Power Wiring Connections (Frame D)

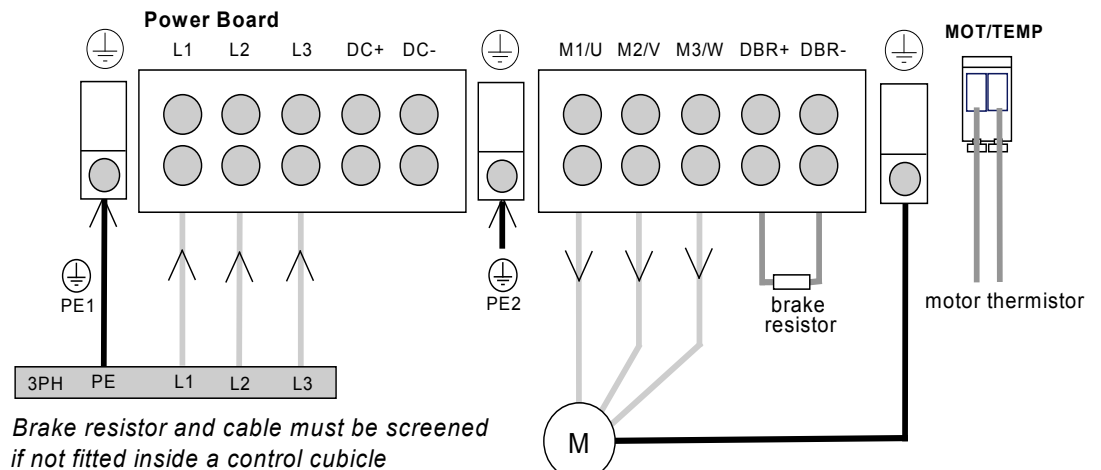

Brake resistor and cable must be screened if not fitted inside a control cubicle

All screens terminated using a gland at the gland plate

1. Remove the terminal cover retaining screws and lift off the terminal cover.
2. Lift the internal power terminal shield.
3. Feed the power supply and motor cables into the drive through the metal gland plate using the correct cable entries, and connect to the power terminals. Tighten all terminals to the correct tightening torque, refer to the Terminal Tightening Torques table.
4. Lower the internal power terminal shield.

Power Wiring Connections (Frame E)

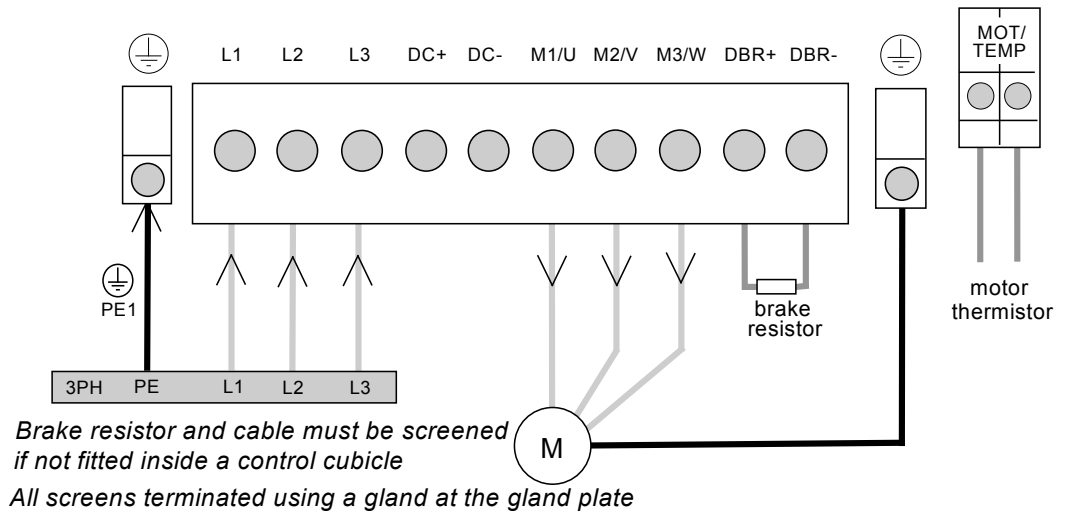

Note: The standard Frame E terminals are not intended for flat busbar. A Power Terminal adaptor is available to enable wiring with flat busbar, part number BE465483.

1. Remove the terminal cover retaining screws and lift off the terminal cover.
2. Feed the power supply and motor cables into the drive through the metal gland plate using the correct cable entries, and connect to the power terminals. Tighten all terminals to the correct tightening torque, refer to the Terminal Tightening Torques table.

Power Wiring Connections (Frame F)

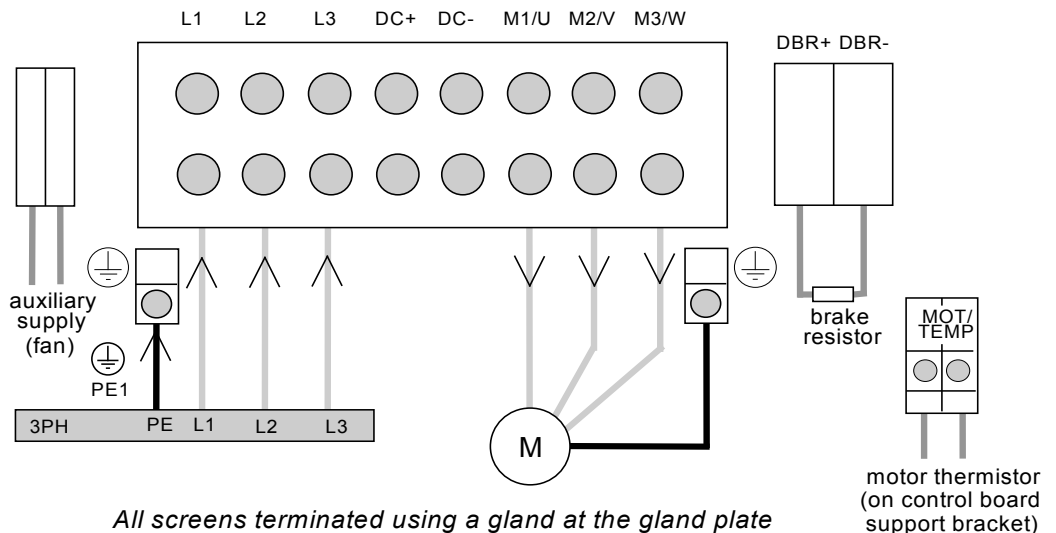

Note: The standard Frame F terminals are not intended for flat busbar. A Power Terminal adaptor is available to enable wiring with flat busbar, part number BE465483.

1. Remove the terminal cover retaining screws and lift off the terminal cover.
2. Feed the power supply and motor cables into the drive through the metal gland plate using the correct cable entries, and connect to the power terminals. Tighten all terminals to the correct tightening torque, refer to the Terminal Tightening Torques table.

IMPORTANT: Remember to provide the auxiliary supply for the Frame F cooling fan. In Chapter 9, check for the correct voltage via the Product Code, and refer to Cooling Fans for correct wiring.

3-16 Installing the Drive

Motor Thermistor Connections

This input is provided to detect over-temperature in motors fitted with an internal thermistor. There is no polarity to the thermistor connections.

IMPORTANT: This input provides “Basic” insulation only to the SELV control circuits and assumes the motor has “Basic” insulation to the windings/mains circuits.

The thermistor type supported is PTC ‘Type A’ as defined in IEC 34-11 Part 2. The drive uses the following resistance thresholds:

Rising temperature trip resistance: 1650 to 4000Ω
Falling temperature trip reset resistance: 750 to 1650Ω

If the motor is not fitted with an internal thermistor, you should disable the thermistor trip function either by setting INVERT THERMISTOR INPUT (°Ot) to 1, or by linking the thermistor terminals.

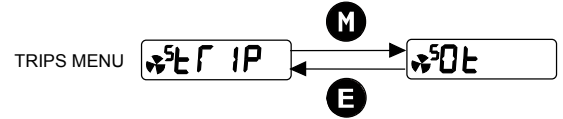

Control Wiring Connections

Control wiring of between 0.08mm² (28AWG) and 2.5mm² (12AWG) can be used. Ensure all wiring is rated for the highest system voltage. All control terminals are SELV, i.e. double-insulated from power circuits.

Terminal (SELV)	Description	Application 1 Default Function (for other Applications refer to Chapter 13: “Applications”)	Range
Scn	RS485 option	Scn=Screen (shield)	-
B	RS485 option	B=RxB/TxB	-
A	RS485 option	A=RxA/TxA	-
P3	P3	RS232 port for use with remote-mounted 6521 and 6901 Keypad or programming PC	-
RL1A	User Relay	Volt-free normally-open relay contact Default function DOUT3 closed = HEALTH	0-250Vac/24Vdc 6A
RL1B	User Relay	Volt-free normally-open relay contact Default function DOUT3 closed = HEALTH	0-250Vac/24Vdc 6A
13	DIN7 (ENC B)	Configurable digital input	0-24V
12	DIN6 (ENC A)	Configurable digital input	0-24V
11	DIN5	Not Coast Stop - configurable digital input: 0V = drive may run, 24V = Coast to Stop	0-24V
10	DIN4/ DOUT2	Configurable digital input/output Not Stop (input): 24V = RUN FWD & RUN REV signals latched 0V = RUN FWD & RUN REV signals not latched	0-24V source open collector *
9	DIN3	Configurable digital input/output Jog (input): 0V = Stop, 24V = Jog	0-24V
8	DIN2	Direction – configurable digital input: 0V = Remote Forward, 24V = Remote Reverse	0-24V
7	DIN1	Run Forward – configurable digital input: 0V = Stop, 24V = Run	0-24V
6	+24V	24V supply for digital I/O	*
5	AOUT1	Ramp Output – configurable analog output (10mA maximum loading)	0-10V
4	10VREF	10V reference (10mA maximum loading)	10V
3	AIN2	Speed Trim – analog input 2	0-10V, 0-5V 0-20mA, 4-20mA
2	AIN1	Speed Setpoint – analog input 1. If unused, tie this input to 0V.	0-10V, 0-5V
1	0V	0V reference for analog/digital I/O	0V

* The total current available is 150mA, either individually or as the sum of terminal 6 & 10.

Terminal Block Acceptance Sizes

Wire sizes for Europe should be chosen with respect to the operating conditions and your local National Electrical Safety Installation Requirements. Local wiring regulations always take precedence. For North American UL wire sizes refer to Chapter 10: "Certification for the Drive" - Requirements for UL Compliance.

Product Code	Power Terminals (minimum/maximum acceptance for aperture)		Control Terminals including Thermistor Terminals
690PC/...	0.75 / 10mm ² (*16mm ²)		2.5 mm ²
690PD/0150/... 690PD/0180/... 690PD/0220/...	2.5 / 16mm ² (* 25mm ²)		2.5 mm ²
690PD/0300/...	2.5 / 25mm ² (* 35mm ²)		2.5 mm ²
	Solid	Stranded	
690PE/...	16 / 50mm ²	25 / 50mm ² (* 70mm ²)	2.5 mm ²
690PF/...	25/120mm ²	35 / 95mm ² (*120mm ²)	2.5 mm ²

Note: The standard Frame E and Frame F terminals are not intended for flat busbar. A Power Terminal adaptor is available to enable wiring with flat busbar, part number BE465483.

* The larger wire sizes can be used provided a crimp is fitted to the wire

Terminal Tightening Torques

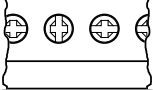
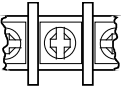
Frame Size	Model Recognition		Thermistor & fan supply	Power Terminals	Brake Terminals	Ground Terminals
	Product Code (Block 2 & 3)	Catalog Code (Block 2 & 3)				
Frame C 230V	0055/230 0075/230	0007/230 0010/230	N/A	1.35Nm (12 lb-in)	1.35Nm (12 lb-in)	2.5Nm (22 lb-in)
Frame C 400/500V	0055/400 0055/500	0007/460	N/A	1.35Nm (12 lb-in)	1.35Nm (12 lb-in)	2.5Nm (22 lb-in)
Frame C 400/500V	0075/400 0110/400 0150/400 0075/500 0110/500 0150/500	0010/460 0015/460 0020C/460	N/A	1.35Nm (12 lb-in) <i>enclosed terminal type</i>  1.8Nm (16 lb-in) <i>open terminal type</i> 	1.35Nm (12 lb-in)	2.5Nm (22 lb-in)
Frame D	All	All	N/A	4Nm (35 lb-in)	4Nm (35 lb-in)	4.5Nm (40 lb-in)
Frame E	All	All	0.7Nm (6.1 lb-in)	6-8Nm (53-70 lb-in)	6-8Nm (53-70 lb-in)	6-8Nm (53-70 lb-in)
Frame F	All	All	0.7Nm (6.1 lb-in)	15-20Nm (132-177 lb-in)	0.7Nm (6.1 lb-in)	42Nm (375 lb-in)

3-18 Installing the Drive

Optional Equipment





Fitting the Remote 6521/6901/6911 Keypad

The 6052 Mounting Kit is required to remote-mount a 6521 Keypad. An enclosure rating of IP54 is achieved for the remote Keypad when correctly mounted using the 6052 Mounting Kit.

6052 Mounting Kit Parts for the Remote Keypad

Tools Required

No. 2 Posidrive screwdriver.

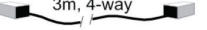
6052 Mounting Kit			
1		1	
1		Steward 28A2025-OAO	
4	 No. 6 x 12mm	1	 3m, 4-way

Assembly Procedure

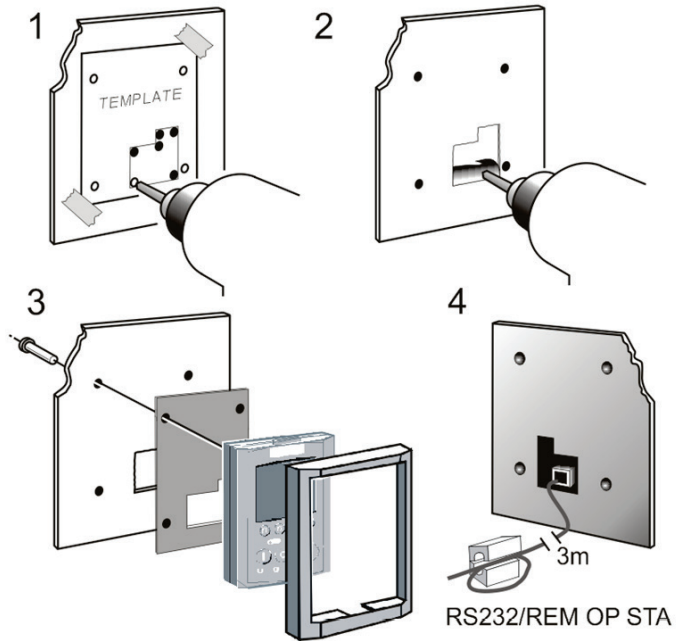

Cutout Dimensions

An actual size template is provided with the Keypad/6052 Mounting Kit.

Figure 3-14 Mounting Dimensions for the Remote-Mounted Keypad 6521/6901/6911

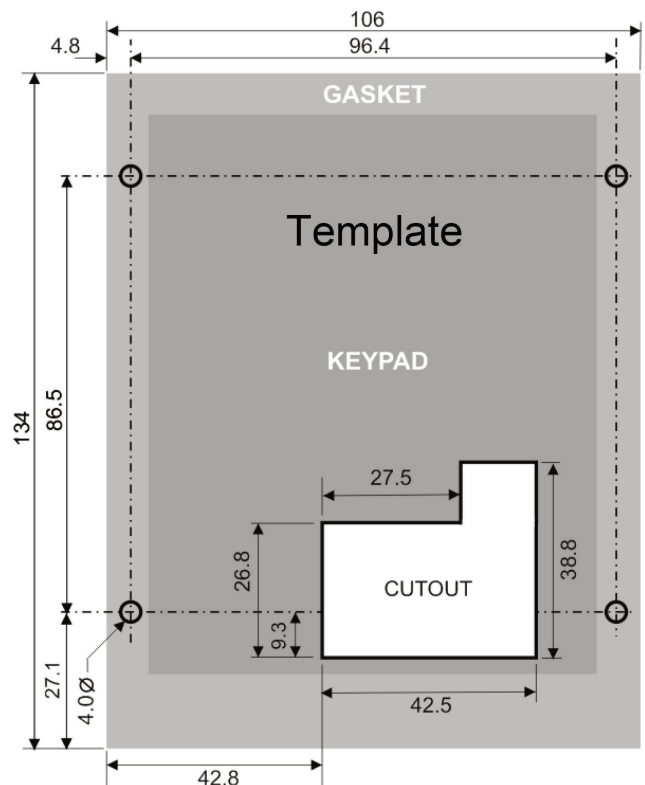

The 6901 and 6911 keypads may be remote mounted and connected to the 650V drive in the same way.

Fitting the Remote 6511 Keypad

Two types of 650 keypad are available:

SSD Part No. 6511/DISP/...	not suitable for remote-mounting
SSD Part No. 6511/DISPR/...	suitable for remote-mounting on drives with an RS232 port

You can remote-mount the keypad using:

- a Remote Keypad (identified by the RS232 connector on the back)
- the RS232 (P3) port located under the terminal cover

A standard P3 lead, Parker SSD Part Number CM057375U300, is used to connect the keypad to the drive.

Two self-tapping screws are provided with the keypad. Remove the protective film from the gasket. An enclosure rating of IP54 is achieved for the remote keypad when correctly mounted.

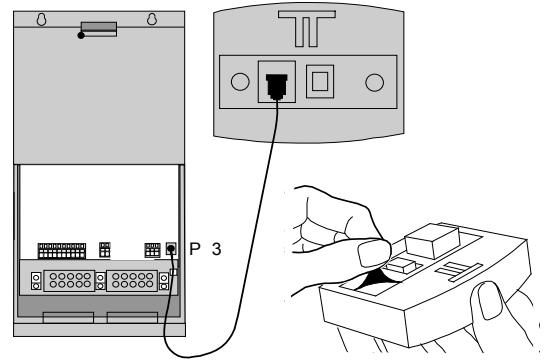

Assembly Procedure

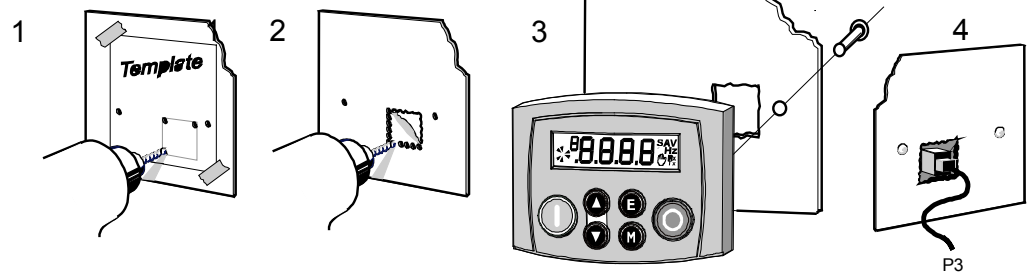

Cut-out Dimensions

The drawing below can be photocopied actual size (100%) and used as a template.

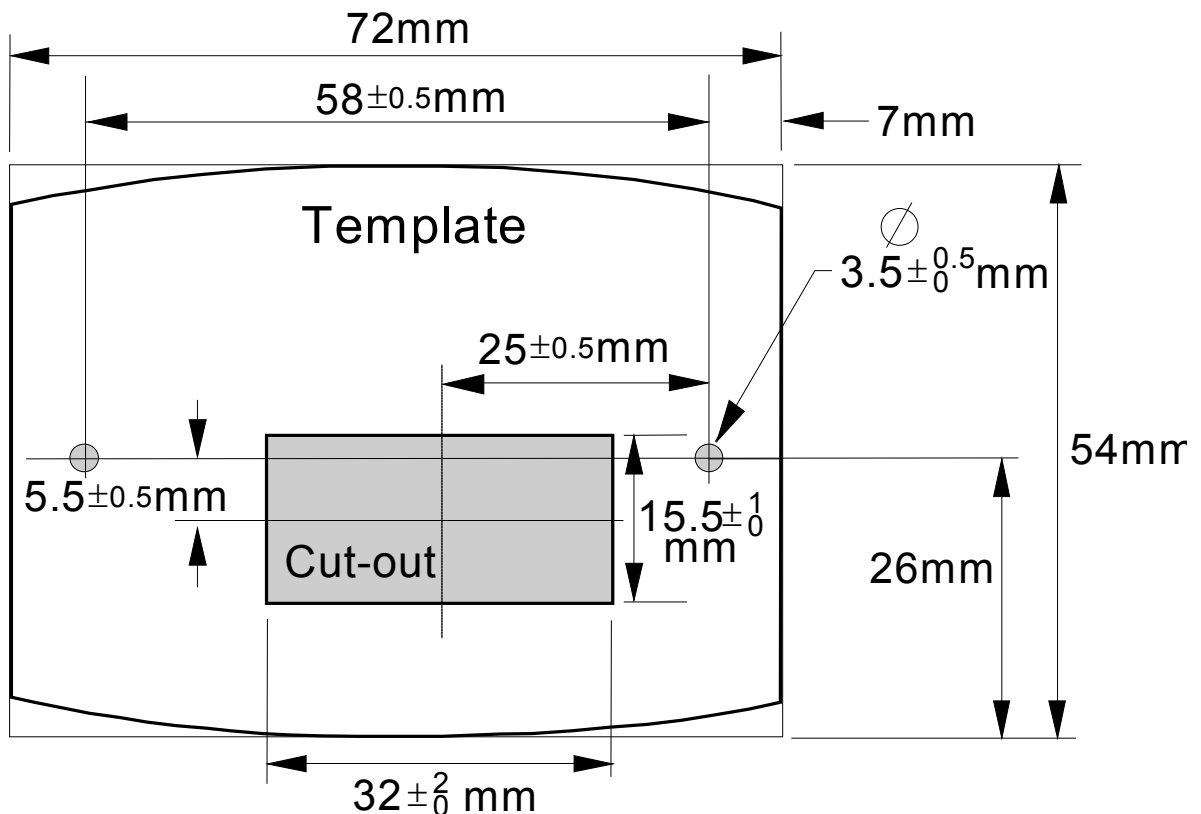

3-20 Installing the Drive

RS485 Communications Option

You can create a network of drives by linking a Master (PC/PLC) to one or more 650V drives fitted with this optional 3-way terminal. It is factory-fitted to the right hand side of the control board.

Signals from the host 650V drive are converted into RS485, and vice versa, so that information can be shared between the Master and 650V drive(s).

Wiring is very simple - all connections are SELV (Safe Extra Low Voltage).

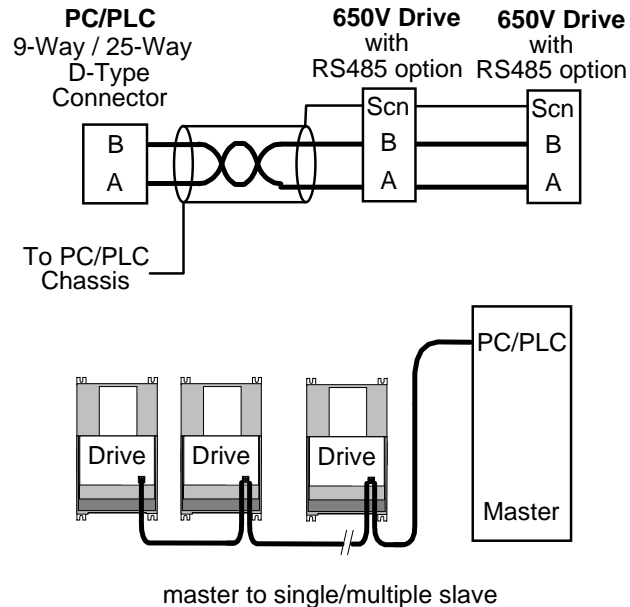

master to single/multiple slave
RS485 Connections

Wiring Specifications	
	RS485 Connections
Network Type	2-Wire Shielded Twisted-Pair
Connections	A=RxA/TxA, B=RxB/TxB, Scn = Screen (shield)
Signal Levels	To RS485 Standard
Receiver Input Impedance	¼ Unit Load
Maximum Cable Length	1200m (4000ft)
Maximum Baud Rate	57.6kbaud
Maximum Number of Units	32 including slaves and masters

Configure the Drive

You must configure the drive to your system. Set-up the parameters in the SERIAL menu as appropriate. For further information refer to the RS485/RS232 Communications Interface Technical Manual, HA466357U001.

For Tag number information refer to the 650V Software Product Manual, available on the Parker SSD Drives website: www.parker.com/ssd

Top Cover

This can be fitted to wall-mounted 650V units to give improved compliance ratings. Refer to Chapter 9: “Technical Specifications” - Environmental Details.

The top cover must be correctly fitted and secured with screw(s).

Note: The maximum operating temperature of the drive is reduced by fitting the top cover. Refer to Chapter 9: “Technical Specifications” - Environmental Details.

Item	Part Number
Top Cover Kit (UL Type 1 / IP4x), including screws <i>A protective cover fitted to wall-mounted units to give improved compliance ratings</i>	
• Frame C	LA465034U002
• Frame D	LA465048U002
• Frame E	LA465058U002

External Brake Resistor

These standard power resistors are available from Parker SSD Drives. These resistors should be mounted on a heatsink (back panel) and covered to prevent injury from burning.

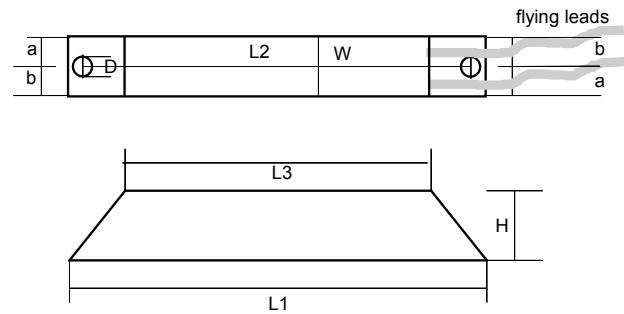

Part Number	CZ463068	CZ388396
Models used on	Frames C, D, E	Frames C, D, E
Resistance	56Ω	36Ω
Maximum Wattage	200W	500W
5 second rating	500%	500%
3 second rating	833%	833%
1 second rating	2500%	2500%
Dimensions L1 (mm)	165	335
L2 (mm)	146	316
L3 (mm)	125	295
W (mm)	30	30
H (mm)	60	60
D (mm)	5.3	5.3
a (mm)	13	13
b (mm)	17	17
Flying lead length (mm)	500	500
Electrical Connection	M5 spade	M5 ring

3-22 Installing the Drive

North American Standard Dynamic Braking Resistor Kits

The Dynamic Braking Resistor kits were designed for stopping a motor at full load current from base speed with two times motor inertia, three times in rapid succession in accordance with NEMA ICS 3-302.62 Dynamic Braking Stop option.

Hp	460 VAC Dynamic Braking Resistor Kit with Cover HEAVY DUTY			460 VAC Dynamic Braking Resistor Kit with Cover NORMAL DUTY		
	Ohms	kW	Catalog No.	Ohms	kW	Catalog No.
7.5	100	0.2	CZ353179	100	0.2	CZ353179
10	54	0.7	CZ353181	100	0.7	CZ353179
15	54	0.84	CZ353181	54	0.84	CZ353181
20	30	1.26	CZ353182	54	1.26	CZ353181
25	30	1.17	CZ353182	30	1.17	CZ353182
30	30	1.56	CZ353182	30	1.56	CZ353182
40	26	2.03	CZ353183	30	2.03	CZ353182
50	18.4	2.36	CZ353185	26	2.36	CZ353183
60	12	2.0	CZ353186	18.4	2.92	CZ353185
75	9	3.39	CZ353188	12	3.39	CZ353186
100	7	3.39	CZ353189	9	3.39	CZ353188
125	5.5	3.39	CZ353190	7	3.39	CZ353189
150	5.5	3.39	CZ353190	5.5	3.39	CZ353190

Brake Resistor Selection

Note: Parker SSD Drives can supply suitable brake resistors.

Brake resistor assemblies must be rated to absorb both peak braking power during deceleration and the average power over the complete cycle.

$$\text{Peak braking power } P_{pk} = \frac{0.0055 \times J \times (n_1^2 - n_2^2)}{t_b} \quad (\text{W})$$

- J - total inertia (kgm²)
- n₁ - initial speed (rpm)
- n₂ - final speed (rpm)
- t_b - braking time (s)
- t_c - cycle time (s)

$$\text{Average braking power } P_{av} = \frac{P_{pk}}{t_c} \times t_b$$

Obtain information on the peak power rating and the average power rating of the resistors from the resistor manufacturer. If this information is not available, a large safety margin must be incorporated to ensure that the resistors are not overloaded.

By connecting these resistors in series and in parallel the braking capacity can be selected for the application.

IMPORTANT: The minimum resistance of the combination and maximum dc link voltage must be as specified in Chapter 10: "Technical Specifications" - Internal Dynamic Brake Switch.

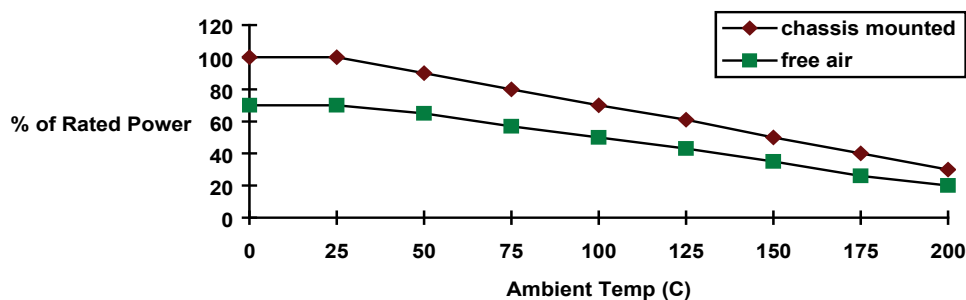

Figure Chapter 3 -15 Brake Resistor Derating Graph

External AC Supply EMC Filter

WARNING!

External filters are available for use with TN and IT supplies. Please check for suitability in Chapter 8: "Technical Specifications" - External AC Supply (RFI) Filters.
Do not touch filter terminals or cabling for at least 3 minutes after removing the ac supply.
Only use the ac supply filter with a permanent earth connection.

Mount the filter as close as possible to the drive.

Note: Follow the cabling requirements given in Chapter 8: "Technical Specifications" Refer to Chapter 9: "External AC Supply (RFI) Filters" for further information.

Footprint/Bookcase Mounting Filters for (Frame C, D, E & F)

These filters can be both footprint and bookcase mounted. They are suitable for wall or cubicle mount, but the filter must be fitted with the appropriate gland box when wall mounted.

The filters for Frames C, D and E look similar. The Frame D filter drawing is given in the following pages. Size variations for the frames are given in the table below.

The Frame F drawing and sizes are also supplied.

Filter Description	Filter Part Number	Terminal Block	Earth Terminal	Gland Mounting	Dimensions	Fixing Centres	Weight
Frame C							
500V IT/TN	CO467842U044	10mm ²	5mm	4 x 4mm	400 x 178x 55mm	384 x 150mm	2.1kg
<i>Gland Plate : BA467840U044</i>							
Frame D							
500V IT/TN	CO467842U084	25mm ²	6mm	4 x 4mm	513 x 233 x 70mm	495 x 208mm	4.2kg
<i>Gland Plate : BA467840U084</i>							
Frame E							
500V IT/TN	CO467842U105	50mm ²	8mm	4 x 4mm	698 x 250 x 80mm	680 x 216mm	6.2kg
<i>Gland Plate : BA467840U105</i>							
Frame F							
500V IT/TN	CO467842U215	95mm ²	8mm	not applicable	825 x 250 x 115mm	795 x 216mm	
<i>Gland Plate : Not applicable</i>							

3-24 Installing the Drive

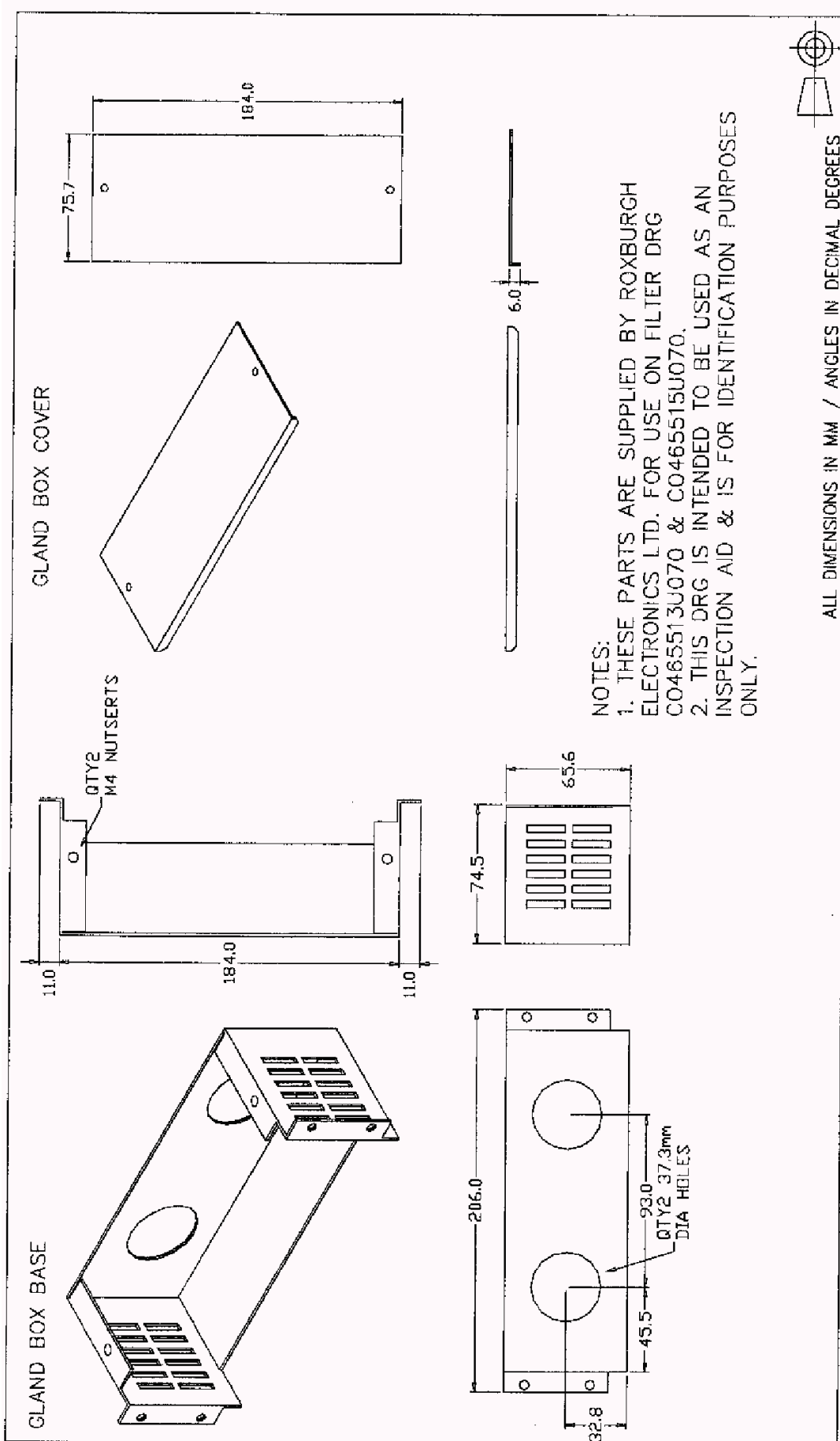

Figure 3-16 Gland Box for Footprint/Bookcase Mounting Filters (generic)

EMC Motor Output Filter

This can help the drive achieve EMC and filter thermal conformance. It also ensures longer motor life by reducing the high voltage slew rate and overvoltage stresses. Mount the filter as close to the VSD as possible. Please refer to Parker SSD Drives for the selection of a suitable filter.

Output Contactors

Output contactors can be used, although we recommend that this type of operation is limited to emergency use only, or in a system where the drive can be inhibited before closing or opening this contactor.

Earth Fault Monitoring Systems

We do not recommend the use of circuit breakers (e.g. RCD, ELCB, GFCI), but where their use is mandatory, they should:

- Operate correctly with dc and ac protective earth currents (i.e. type B RCDs as in Amendment 2 of IEC755).
- Have adjustable trip amplitude and time characteristics to prevent nuisance tripping on switch-on.

When the ac supply is switched on, a pulse of current flows to earth to charge the internal/external ac supply EMC filter's internal capacitors which are connected between phase and earth. This has been minimised in Parker SSD Drives' filters, but may still trip out any circuit breaker in the earth system. In addition, high frequency and dc components of earth leakage currents will flow under normal operating conditions. Under certain fault conditions larger dc protective earth currents may flow. The protective function of some circuit breakers cannot be guaranteed under such operating conditions.

WARNING!

Circuit breakers used with VSDs and other similar equipment are not suitable for personnel protection. Use another means to provide personal safety. Refer to EN50178 / VDE0160 / EN60204-1

Line Chokes (input)

Line chokes may be used to reduce the harmonic content of the supply current where this a particular requirement of the application or where greater protection from mains borne transients is required. Please refer to Parker SSD Drives for the selection of a suitable line choke for Frames C and D.

AC Motor Choke (output)

Installations with long cable runs may suffer from nuisance overcurrent trips, refer to Chapter 9: "Technical Specifications" - Cabling Requirements for maximum cable lengths. A choke may be fitted in the drive output to limit capacitive current. Screened cable has a higher capacitance and may cause problems in shorter runs. Contact Parker SSD Drives for recommended choke values.

3-26 Installing the Drive

Encoder Connections

The drive is **only** suitable for use with single-ended encoders. Take special care wiring the encoder to the drive due to the low level of the signals.

All wiring to the drive should be made in screened cable. Use cable with an overall screen and a screen over each individual pair. To ensure compliance with the EMC Directive the overall cable screen should be connected to the drive chassis.

Recommended cable (pairs individually screened):

Belden equivalent 8777

SSD Drives Part Number CM052666

The drive will operate with 5-24V encoders. Provide the correct supply for the encoder. Do not use the 10V or 24V supply from the drive.

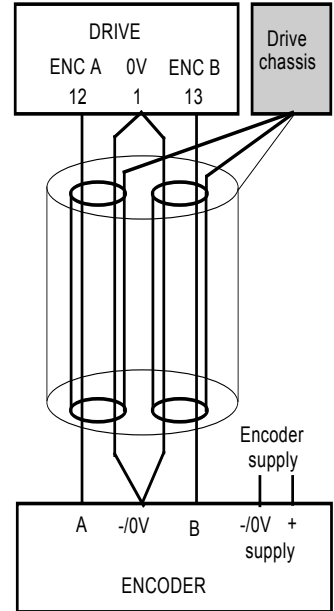

Chapter 4

OPERATING THE DRIVE

Pre-Operation Checks

WARNING!

Wait for 5 minutes after disconnecting power before working on any part of the system or removing the terminal cover from the drive.

Initial checks before applying power:

- Check for damage to equipment.
- Mains power supply voltage is correct.
- Motor is of correct voltage rating and is connected in either star or delta, as appropriate.
- Check all external wiring circuits - power, control, motor and earth connections.

Note: Completely disconnect the drive before point to point checking with a buzzer, or when checking insulation with a Meggar.

- Check for loose ends, clippings, drilling swarf etc. lodged in the drive and system.
- If possible check that the motor can be turned freely, and that any cooling fans are intact and free from obstruction.

Ensure the safety of the complete system before the drive is energised:

- Ensure that rotation of the motor in either direction will not cause damage.
- Ensure that nobody else is working on another part of the system which will be affected by powering up.
- Ensure that other equipment will not be adversely affected by powering up.

Prepare to energise the drive and system as follows:

- Remove the supply fuses, or isolate using the supply circuit breaker.
- Disconnect the load from the motor shaft, if possible.
- If any of the drives control terminals are not being used, check whether these unused terminals need to be tied high or low.
- If the motor thermistor terminals are not connected to a motor thermistor, connect these terminals together.
- Check external run contacts are open. Check external speed setpoints are all zero.

Re-apply power to the drive and system

Initial Start-up Routines

Refer to Chapter 5: "Using the Keypad" to familiarise yourself with the keypad's indications, and how to use the keys and menu structure.



IMPORTANT

When power is applied to the drive in Remote Control, it will immediately start running if the RUN signal is active.

WARNING!

Unpredictable motion, especially if motor parameters are incorrect.
Ensure no personnel are in the vicinity of the motor or any connected machinery.
Ensure that machinery connected to the motor will not be damaged by unpredictable motion.
Ensure that the emergency stop circuits function correctly before running the motor for the first time.

The drive can be started in either Remote Control or Local Control. **By default, the drive will start in Local Control.**

These routines assume that the drive's control terminals are wired as shown in the Control Wiring Connections in Chapter 3.

Connected in this way, a positive setpoint will rotate the motor in a clockwise direction when viewed down the shaft, looking toward the motor.

Note: If during the start-up routine the display shows either an alarm (indicated by the letter "A") or a flashing Warning message, refer to Chapter 7: "Trips and Fault Finding".



A typical alarm

4-2 Operating the Drive

Local Control Operation

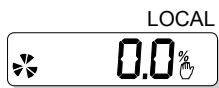

This is the simplest method of operating the drive. The drive can only operate in V/F fluxing control mode (VOLTS/Hz). Connect the keypad to the drive and power-up the unit. The drive will display the Local screen. If not, refer to Chapter 5 and select Local Control.

Follow the instructions opposite to start and stop the motor.

Reverse: Instead of setting a negative setpoint, you can reverse the motor direction by pressing STOP + ▼, or START + ▼.

To change the direction to forwards, (the normal direction), press STOP + ▲ or START + ▲.

Note that the Setpoint parameter will not change sign to indicate this change, however the rotating indicator on the MMI will show the direction.

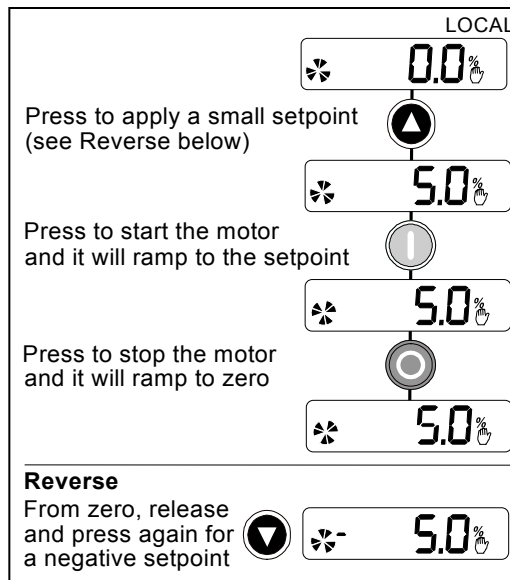

We recommend that you use the STOP key commands if the motor is stopped, and the START key commands if the motor is running. The keys should be pressed and released together.

Remote Control Operation

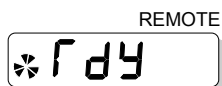

Connect the keypad to the drive and power-up the unit.

The drive will display the Local screen. Refer to Chapter 5 and select Remote Control.

IMPORTANT: Ensure that the speed potentiometer is set to zero.

Follow the instructions below to start and stop the motor using your control panel.

Reverse the motor's direction of rotation using the DIN2 connection (0V = forward, +24V = reverse). Alternatively, swap two of the motor phases (**WARNING: Disconnect the mains supply first**).

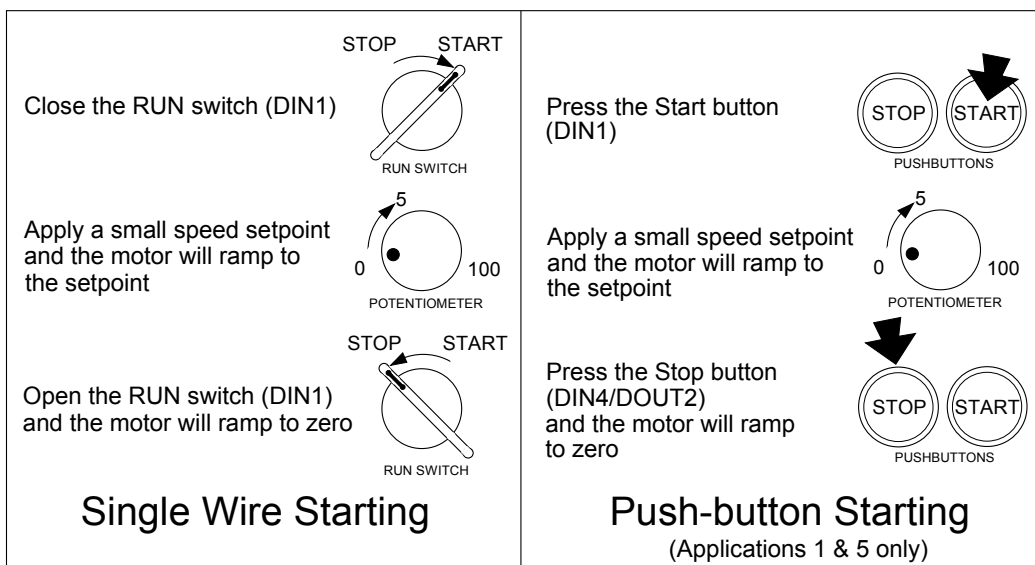

The installation of your drive is now complete:

The drive will operate as an open-loop drive. It is programmed to control an induction motor of equivalent power, current, and voltage rating to the drive. Using the keypad (or other suitable programming tool) the drive must now be set-up:

- as a simple Open-loop drive (V/F Fluxing Mode)
provides less torque control at low speeds, but is ideal for controlling fans and pumps
- in Sensorless Vector Fluxing mode
used for maximum torque control at low speeds, for example, in operating a lift

Set-up as an Open-loop Drive (V/F Fluxing)

The parameters most likely to require attention in this (default) control mode (VOLTS / HZ) are shown below.

Display	Parameter	Default	Brief Description
P 2	MAX SPEED	Default is Product Code dependent	Set the speed in Hz at which the 650V will run when the maximum setpoint is applied
P 3	MIN SPEED	0.0%	Minimum speed clamp
P 4	ACCEL TIME	10.0 s	The time taken for the 650V output frequency to ramp up from zero to MAX SPEED
P 5	DECEL TIME	10.0 s	The time taken for the 650V output frequency to ramp down from MAX SPEED to zero
P 6	MOTOR CURRENT	Default is Product Code dependent	Enter the motor nameplate full-load line current
P 7	BASE FREQUENCY	Default is Product Code dependent	Enter the output frequency from the motor nameplate
P 8	JOG SETPOINT	10.0 %	Drive speed setpoint whilst jogging
P 9	RUN STOP MODE	0	Selects a type of "ramp to standstill", for when RUN signal is removed
P 11	V/F SHAPE	LINEAR	Constant torque V to F characteristic
P 12	HEAVY/NORMAL DUTY	0	Selects between Heavy or Normal mode of operation
P 13	FIXED BOOST	Default is Product Code dependent	Enter a boost for starting torque to help with high friction loads
5CL01	CONTROL MODE	VOLTS / HZ (0)	This parameter contains the main method of motor control used by the drive, and by default is set to VOLTS/HZ

Additional parameters for when parameters ^c04 (SLIP COMP ENABLE) and/or ^c05 (STABILISATION ENABLE) are enabled:

5CL02	NAMEPLATE RPM	1445.0	This parameter contains the motor nameplate full-load rated speed. This is the motor speed in rpm at base frequency minus full load slip
5CL11	MOTOR POLES	4 pole	This parameter contains the motor nameplate poles
5CL12	MOTOR VOLTAGE	Default is Product Code dependent	This parameter contains the motor nameplate voltage at base frequency
5CL14	MAG CURRENT	Default is Product Code dependent	This parameter contains the motor model no-load line current as determined by the Autotune

4-4 Operating the Drive

Set-up using the Sensorless Vector Fluxing Mode

The drive must be tuned to the motor in use by matching the motor parameters in the drive to those of the motor being controlled.

IMPORTANT: You **MUST** use the Autotune feature.

Enter values for the following parameters.

Display	Parameter	Default	Brief Description
P 2	MAX SPEED	Default is Product Code dependent	Set the speed in Hz at which the 650V will run when the maximum setpoint is applied
P 3	MIN SPEED	0.0%	Minimum speed clamp
P 4	ACCEL TIME	10.0 s	The time taken for the 650V output frequency to ramp up from zero to MAX SPEED
P 5	DECEL TIME	10.0 s	The time taken for the 650V output frequency to ramp down from MAX SPEED to zero
P 6	MOTOR CURRENT	Default is Product Code dependent	Enter the motor nameplate full-load line current
P 7	BASE FREQUENCY	Default is Product Code dependent	Enter the output frequency from the motor nameplate
P 8	JOG SETPOINT	10.0 %	Drive speed setpoint whilst jogging
P 9	RUN STOP MODE	0	Selects a type of "ramp to standstill", for when RUN signal is removed
P 12	HEAVY/NORMAL DUTY	0	Selects between Heavy or Normal mode of operation
5CL01	CONTROL MODE	SENSORLESS VEC (1)	This parameter contains the main method of motor control used by the drive, and by default is set to VOLTS/HZ
5CL02	NAMEPLATE RPM	1445.0	Enter the motor nameplate full-load rated speed. This is the motor speed in rpm at base frequency minus full load slip
5CL11	MOTOR POLES	4-pole	Enter the number of motor poles shown on the motor nameplate
5CL12	MOTOR VOLTAGE	Default is Product Code dependent	Enter the motor nameplate voltage at base frequency
5CL20	AUTOTUNE MODE	0	Selects the Autotune operating mode.
5CL21	AUTOTUNE ENABLE	0	Enables the Autotune feature

The Autotune Feature

IMPORTANT: You **MUST** carry out an Autotune if you intend to use the drive in Sensorless Vector Fluxing Mode. If you are using it in Volts/Hz control an Autotune is not necessary.

The Autotune feature identifies motor characteristics to allow the drive to control the motor. It loads the values into the parameters below.

Display	Description	Note
5CL14	MAG CURRENT	Magnetising current. Not measured by Stationary Autotune
5CL17	STATOR RES	Per phase stator resistance
5CL18	LEAKAGE INDUC	Per phase stator leakage inductance
5CL19	MUTUAL INDUC	Per phase mutual inductance
5CL1A	ROTOR TIME CONST	Rotor time constant. This is identified from magnetising current and motor nameplate rpm

Stationary or Rotating Autotune?

Will the motor spin freely, i.e. not connected to a load, during the Autotune?

- If it can spin freely, use a Rotating Autotune (preferred)
- If it cannot spin freely, use a Stationary Autotune

	Action	Requirements
Rotating Autotune <i>Preferred method</i>	Spins the motor up to the maximum speed set by the user to identify all necessary motor characteristics	Motor must spin freely during Autotune
Stationary Autotune <i>Only used when the motor cannot spin freely during the Autotune feature</i>	Motor does not spin during Autotune. A limited set of motor characteristics are identified	You must enter the correct value of magnetising current Do not subsequently operate the drive above base speed

Necessary Data

You **MUST** enter values for the following parameters before an Autotune can be carried out:

MOTOR CURRENT
 BASE FREQUENCY
 MOTOR VOLTAGE (maximum motor output voltage)
 NAMEPLATE RPM (motor nameplate speed)
 MOTOR POLES (the number of motor poles)

Performing a Rotating Autotune

Check that the motor can rotate freely in the forward direction. Ensure also that the motor is unloaded. Ideally, the motor shaft should be disconnected. If the motor is connected to a gearbox this is ok, provided that there is nothing on the output of the gearbox which could load the motor.

1. Set MAX SPEED (^P 2) to the maximum speed at which you will operate the drive in normal operation. The Autotune will characterise the motor up to 30% above this speed. If you later wish to run faster than this, you will need to carry out another Autotune.
2. Set the AUTOTUNE MODE (S CL20) parameter to ROTATING(1).
3. Set AUTOTUNE ENABLE (^S CL21) to 1 (TRUE), and start the drive. The drive will carry out a Rotating Autotune, indicated by the Run and Stop led's flashing on the blank cover when fitted, or by flashing **Alt N** on the keypad. This may take several minutes, during which the motor will be accelerated to maximum speed and then brought to a stop. When complete, the drive is returned to the stopped condition and the AUTOTUNE ENABLE parameter is reset to 0 (FALSE).

Performing a Stationary Autotune

Before starting the stationary Autotune, you **MUST** enter the value of magnetising current for the motor (^S CL14). This may be available on the motor nameplate. If not, you may need to contact the motor supplier.

1. Set the AUTOTUNE MODE (S CL20) parameter to STATIONARY(0).
2. Set AUTOTUNE ENABLE (^S CL21) to 1 (TRUE), and start the drive. The drive will carry out a Stationary Autotune, injecting current into the motor but not turning the shaft. The Run and Stop led's will flash on the blank cover when fitted, or **Alt N** will flash on the keypad. When complete, the drive is returned to the stopped condition and the AUTOTUNE ENABLE parameter is reset to 0 (FALSE).

4-6 Operating the Drive

Reading the Status LEDs

The Keypad can be replaced with the Blank Cover.

The HEALTH and RUN LEDs indicate status. The LEDs are considered to operate in five different ways:

- OFF
- SHORT FLASH
- EQUAL FLASH
- LONG FLASH
- ON

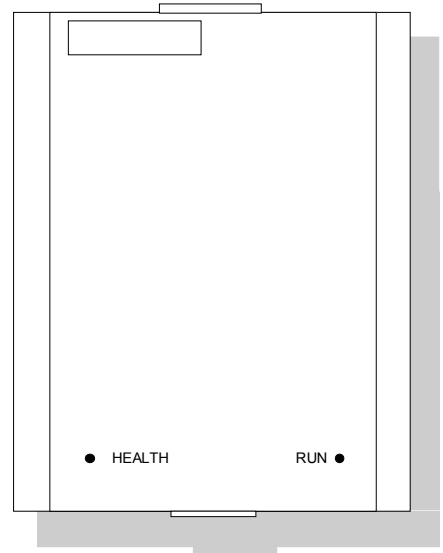

HEALTH	RUN	Drive State
<input type="checkbox"/> <input checked="" type="checkbox"/>	<input type="checkbox"/> <input checked="" type="checkbox"/>	Re-configuration, or corrupted non-volatile memory at power-up
<input type="checkbox"/> <input checked="" type="checkbox"/>	<input type="checkbox"/>	Tripped
<input type="checkbox"/> <input checked="" type="checkbox"/>	<input type="checkbox"/> <input checked="" type="checkbox"/>	Auto Restarting, waiting for trip cause to clear
<input type="checkbox"/> <input checked="" type="checkbox"/>	<input type="checkbox"/> <input checked="" type="checkbox"/>	Auto Restarting, timing
<input checked="" type="checkbox"/>	<input type="checkbox"/>	Stopped
<input checked="" type="checkbox"/>	<input checked="" type="checkbox"/> <input type="checkbox"/>	Running with zero reference, enable false or contactor feedback false
<input checked="" type="checkbox"/>	<input checked="" type="checkbox"/>	Running
<input checked="" type="checkbox"/>	<input type="checkbox"/> <input checked="" type="checkbox"/>	Stopping
<input checked="" type="checkbox"/> <input type="checkbox"/>	<input checked="" type="checkbox"/> <input type="checkbox"/>	Braking and running with zero speed demand
<input checked="" type="checkbox"/> <input type="checkbox"/>	<input checked="" type="checkbox"/>	Braking and running
<input checked="" type="checkbox"/> <input type="checkbox"/>	<input type="checkbox"/> <input checked="" type="checkbox"/>	Braking and stopping

Table 4-1 Status indications given by the Blank Cover Health and Run LEDs

Chapter 5

THE KEYPAD

The 650V can be fitted with a Keypad (Man-Machine Interface, MMI).

It provides for local control of the drive, monitoring, and complete access for application programming a connection to a pc is required along with the drive software tool.

Insert the Keypad into the front of the drive (replacing the blank cover and plugging into the RS232 programming port); or mount it up to 3 metres away using the optional mounting kit with connecting lead: refer to Chapter 3: "Installing the Drive" – Fitting the Remote 6521 Keypad.

The Power-Up Condition

On initial power-up, direct from the factory, the drive is in Local Control and the MMI will display the Local Setpoint, **0.0** Hz.

All parameters will be at factory default settings. Any changes to these conditions are automatically saved. The drive will initialise on subsequent power-ups with the previously saved settings and control mode.

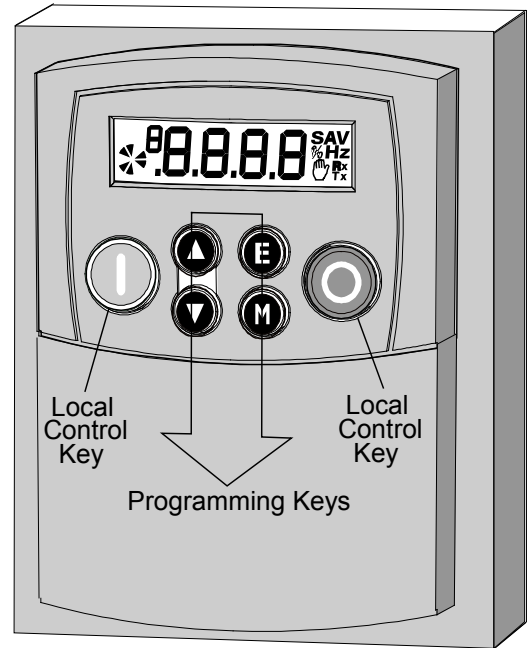

The 6521 Keypad

Using the Keypad

Control Key Definitions

Key	Operation	Description
	Escape	<i>Navigation</i> – Displays the previous level's menu <i>Parameter</i> – Returns to the parameter list <i>Trip Display</i> – Removes Trip or Error message from display allowing investigation of parameters
	Menu	<i>Navigation</i> – Displays the next menu level, or the first parameter of the current Menu <i>Parameter</i> – Moves cursor to the left when the parameter is adjustable
	Increment	<i>Navigation</i> – Move upwards through the menu system <i>Parameter</i> – Increase value of the displayed parameter <i>Local Mode</i> – Increase value of the local setpoint
	Decrement	<i>Navigation</i> – Move down through the menu system <i>Parameter</i> – Decrease value of the displayed parameter <i>Local Mode</i> – Decrease value of the local setpoint
	Run	<i>Local Mode</i> – Run the drive <i>Trip Reset</i> – Resets trip condition allowing drive to resume operation
	Stop	<i>Local Mode</i> – Stops the drive. Trip Reset in all modes <i>Navigation</i> – Press and hold to toggle between Local and Remote Control modes (refer to page 5-4) <i>Trip Reset</i> – Resets trip condition allowing drive to resume operation

5-2 The Keypad

Display Indications

P when in the Parameter menu
S when in the Setup menu
A when displaying an Alarm code
- a negative parameter value

Displays the units for the value:
S for time in seconds, **A** for current in Amps
V for voltage in Volts, **%** for percentage
Hz for frequency in Hertz

Indicates the Control Mode

Indicates parameter numbers or values, trip information, error codes etc. See "Drive Status Indications" below.

Indicates the drive is in Local control. *Drive is in remote control when not visible.*

Indicates control via fieldbus communications

Represents a rotating shaft:
 clockwise = drive running forward
 anticlockwise = drive running in reverse

Drive Status Indications

The keypad can display the following status information:

Display	Status Indication and Meaning	Possible Cause
	READY/HEALTHY No alarms present. Remote Control selected	
	PASSWORD Current password must be entered before this parameter may be altered.	Enter password to change the parameter. Refer to page 5.5-5
	LOCAL Local Control selected	Added or removed from the display letter-by-letter to indicate entering or leaving Local Control
	STOP Coast Stop or Prog Stop active	Jog (6901 op station only) or Run pressed while Coast Stop or Prog Stop lines are active, (low), on the sequencing block. Local control only.
	RUN Not possible to change between Local/Remote mode	The drive is running in Local mode or the Remote run signal is active
	JOG Not possible to change between Local/Remote mode	The Remote jog signal is active
	ENABLE Pressed RUN or JOG key in Local mode while Enable signal is low	The drive Enable signal is inactive, (low)

The Menu System

The menu system is divided into a “tree” structure.

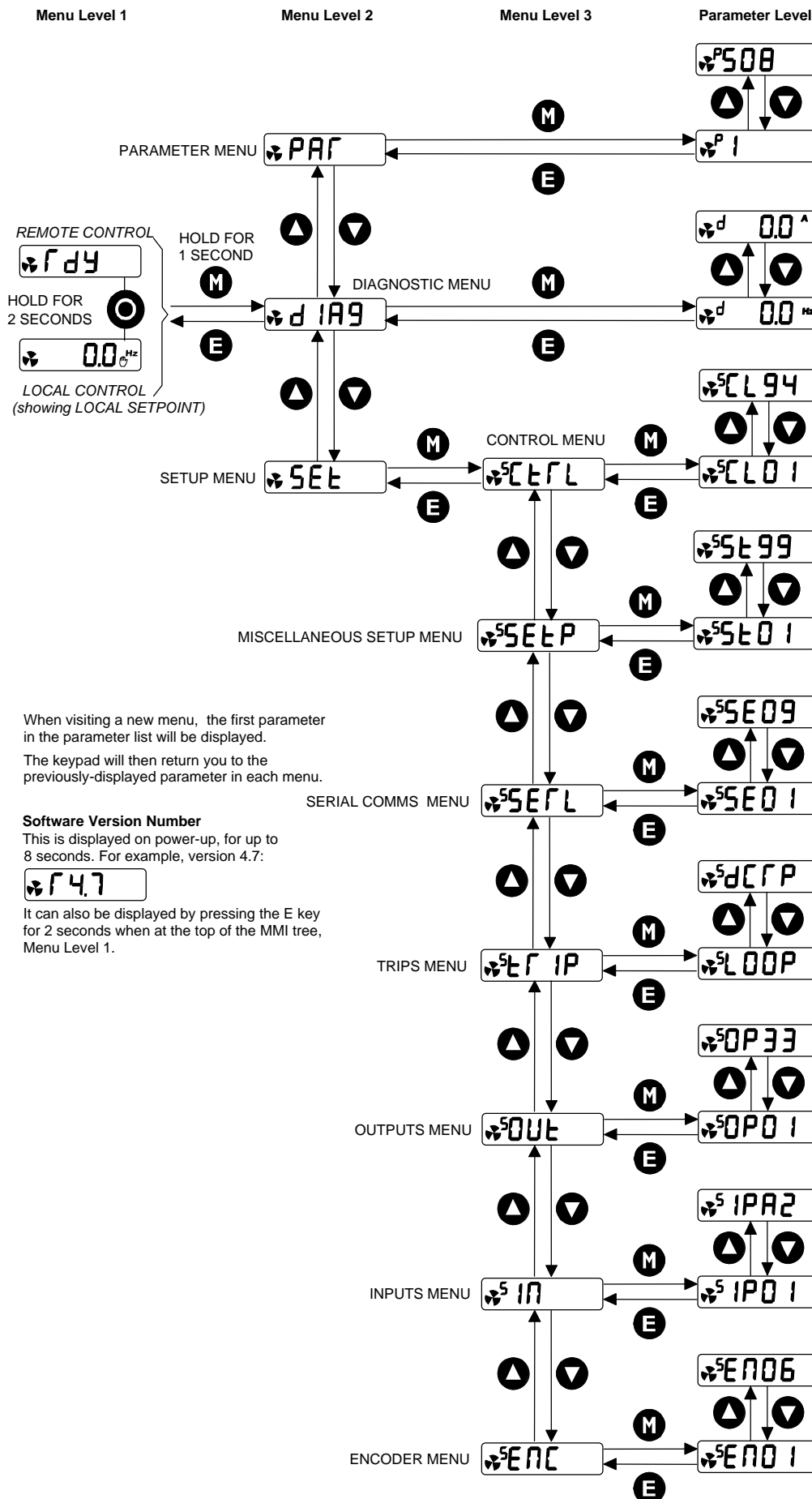

When visiting a new menu, the first parameter in the parameter list will be displayed. The keypad will then return you to the previously-displayed parameter in each menu.



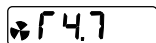

Software Version Number
 This is displayed on power-up, for up to 8 seconds. For example, version 4.7:



It can also be displayed by pressing the E key for 2 seconds when at the top of the MMI tree, Menu Level 1.

5-4 The Keypad

How To Change a Parameter Value



- View the parameter to be edited and press  to display the parameter's value.
- Select the digit to be changed (pressing the  key moves the cursor from right to left).
- Use the   keys to adjust the value. Hold the key momentarily to adjust the value marginally, or hold the key to make rapid changes; the rate of change varies with the time held.
- Press  to return to the parameter display. The new value is stored.

Special Menu Features

Resetting to Factory Defaults (2-button reset)

Power-up the drive whilst holding the keys as shown to return to factory default settings.

This loads Application 1. Then press the  key.

Hold down the keys opposite:   *HOLD*
 Power-up the drive, continue to hold for at least 1 second

Selecting Local or Remote Control

The drive can operate in one of two ways:

- Remote Control:** Allowing access for application programming using digital and analog inputs and outputs
- Local Control:** Providing local control and monitoring of the drive using the Keypad

Local control keys are inactive when Remote Control is selected.

In Remote Control, the drive uses a remote setpoint. In Local Control, it uses the Local Setpoint parameter whose value is adjusted on the MMI.

Note: You can only change between Local and Remote Control when the drive is "stopped", and either  or the Local Setpoint is displayed.

Remote to Local Control:

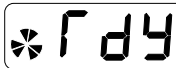
Hold this key down until the display shows 

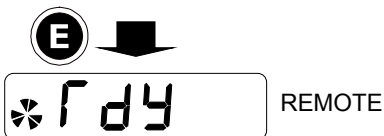

Hold this key down until the display spells 

Release the key to display the Local Setpoint



Local to Remote Control:

View the Local Setpoint

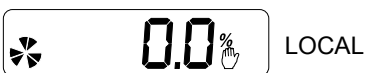

Hold this key down until  is removed from the display

Release the key to display 



Note: For safety reasons, the drive will not return to Remote Control if this will cause the drive to start. Check RUN and JOG inputs are low.

Password Protection

When activated, an odd-numbered password prevents unauthorised parameter modification by making all parameters read-only. The local setpoint is not made read-only if an even-numbered password is used. Password protection is set-up using the **P 99** parameter

Steps	ACTIVATE		TEMPORARY DE-ACTIVATION		REMOVE PASSWORD	
	Actions	Display	Actions	Display	Actions	Display
1	Go to P 99 Press M	0000	Try to edit any parameter with password activated	PASS → 0000	Go to P 99 Press M	PASS → 0000
2	Enter new password using ▲ ▼	000 1 for example	Enter current password using ▲ ▼	000 1 for example	Enter current password using ▲ ▼	000 1 for example
3	Press E repeatedly until top of menu is reached	r dY , Remote Setpoint or Local Setpoint	Press E	Original parameter displayed, password de-activated	Press E Reset to 0000 using ▲ ▼	0000
4	Press E to activate password	r dY , Remote Setpoint or Local Setpoint	<i>A drive will power-up with the last password status. Temporary de-activation is lost on power-down.</i>		Press E to remove password	P 99
	<i>Default = 0000, de-activated Any other value is a password</i>					

Quick Application Selection

You can navigate immediately to the APPLICATION parameter, **P1**, from power-up, as shown opposite.

Hold down the key opposite:  **HOLD**
 Power-up the drive, continue to hold for at least 1 second

Then, press the **M** key to display the current Application.

Use the **▲** **▼** keys to select the appropriate Application by number.

Press the **E** key to load the Application.

Refer to Chapter 13: "Applications" for further information.

5-6 The Keypad

Chapter 6

PROGRAMMING YOUR APPLICATION

MMI Parameters

Note: Included here is an "Operators" list of all the parameters available using the keypad. For more information about these and additional parameters accessible using DSE Lite (or other suitable programming tool), refer to the 650V Software Product Manual on our website: www.parker.com/ssd

You can program the drive to your specific application. This programming simply involves changing parameter values. For instance, parameter ^P1 selects various Applications which can be used as starting points for application-specific programming.

Each Application internally re-wires the drive for a different use when it is loaded. The default for the parameter is "1". Changing this parameter's setting to "2" will load Application 2. Refer to Chapter 13: "Applications" for further information.

If necessary, there are three parameters for tuning your drive. Refer to PID - Tuning Your Drive, page 6-14.

Saving Your Modifications

When parameter values are modified or an Application is loaded, the new settings are saved automatically. The drive will retain the new settings during power-down.

The Diagnostics Menu

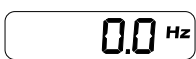
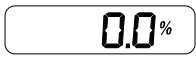
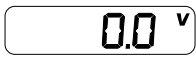
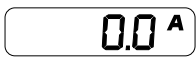
Display	Name	Description
	FREQUENCY	The current output frequency in Hertz
	SPEED SETPOINT	The set point as a percentage of MAX SPEED
	DC LINK VOLTS	$V_{ac} (rms) \times \sqrt{2} = dc \text{ link Volts}$ (when motor stopped)
	MOTOR CURRENT	The current load value in Amps

MMI Parameters Table

Key to MMI Parameters Table

F	Parameters indicated with F are visible with Full menus only. Refer to the DETAILED MENUS parameter (ST 99).
M	Parameters indicated with M are Motor Parameters. They are not reset by changing Application using parameter ^P 1; all other parameters are reset to default values.
VF	Parameters indicated with VF are only visible when the drive is in VF (Volts/Hz) motor control mode, as selected by parameter ^S CL01.
SV	Parameters indicated with SV are only visible when the drive is in SV (Sensorless Vector) motor control mode, as selected by parameter ^S CL01.

Note: The "Range" for a parameter value is given in the Configurable Parameters Table. Ranges for outputs are given as "—.xx %", for example, indicating an indeterminate integer for the value, to two decimal places.

6-2 Programming Your Application

MMI Parameters Table				
Display	Parameter	Description	Range	Default
SET::PAR Menu				
P 1	APPLICATION	This parameter selects and loads the Application to be used. APP 0 will not control a motor. APP 6, 7 & 8 are for future use. You can edit an Application in DSE and then set this parameter to CUSTOM to produce your own custom Application. Refer to the 650V Software Product Manual, Chapter 5: "Applications" which gives detailed information about each Application. Note: Parameter values are changed to factory settings by loading a new Application, except Motor Parameters (indicated M)	0= NULL 1= STANDARD 2= LOCAL/REM (AUTO/MANUAL) 3= PRESETS 4= RAISE/LOWER 5= PID 6= APP 6 7= APP 7 8= APP 8 9= CUSTOM	1
P 2	MAX SPEED M	The frequency at which the 650V will run when maximum setpoint is applied. The default is Product Code dependent	7.5 to 300Hz	50 or 60Hz
P 3	MIN SPEED	The minimum frequency at which the 650V will run, as a percentage of the MAX SPEED parameter	-100.0 to 100.0%	0.0%
P 4	ACCEL TIME	The time taken for the 650V output frequency to ramp up from zero to MAX SPEED	0.0 to 3000.0s	10.0s
P 5	DECEL TIME	The time taken for the 650V output frequency to ramp down from MAX SPEED to zero	0.0 to 3000.0s	10.0s
P 6	MOTOR CURRENT M	This parameter contains the motor nameplate full-load line current	0.01 to 999.99A	product code dependent
P 7	BASE FREQUENCY M	The output frequency at which maximum voltage is reached. The default is Product Code dependent	7.5 to 240Hz	50 or 60Hz
P 8	JOG SETPOINT	Speed the 650V will run at if the Jog input is high, as a percentage of the MAX SPEED parameter	-100.0 to 100.0%	10.0%
P 9	RUN STOP MODE	RAMPED : The motor speed is reduced to zero at a rate set by DECEL TIME (P5). A 2 second DC pulse is applied at end of ramp COAST : The motor is allowed to freewheel to a standstill DC INJECTION : On a stop command, the motor volts are rapidly reduced at constant frequency to deflux the motor. A low frequency braking current is then applied until the motor speed is almost zero. This is followed by a timed DC pulse to hold the motor shaft.	0=RAMPED 1=COAST 2=DC INJECTION	0
P 11	V/F SHAPE	LINEAR LAW: This gives a constant flux characteristic up to the BASE FREQUENCY FAN LAW: This gives a quadratic flux characteristic up to the BASE FREQUENCY. This matches the load requirement for fan and most pump applications Refer to P12	0=LINEAR LAW 1=FAN LAW	0

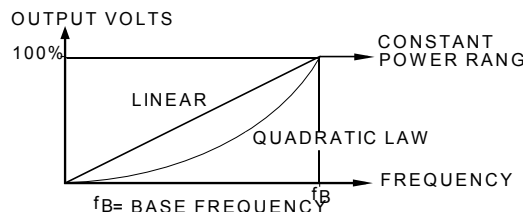

MMI Parameters Table

Display	Parameter	Description	Range	Default
P 12	NORMAL DUTY	<p>% OF RATED MOTOR CURRENT</p> <p>150% 127.5% 105% 100%</p> <p>30 60</p> <p>TIME (s)</p> <p>100% overload for 30s (Heavy Duty)</p> <p>FALSE - HEAVY DUTY: Inverse time allows 150% overload for 30s, then ramps back the current limit to 105% over a 10s period. At a lower load, the overload area remains the same, e.g. at 127.5% load for 60s - after 60s has expired, the output of the inverse time function is ramped back over a 10s period from 150% as before.</p> <p>TRUE - NORMAL DUTY: current limit is set to 110% motor current, inverse time delay is set to 30s</p> <p>When P11 is changed from FAN LAW to LINEAR LAW, P12 is set to 0 (HEAVY DUTY)</p> <p>When P11 is changed from LINEAR LAW to FAN LAW, P12 is set to 1 (NORMAL DUTY)</p> <p>P12 can be changed independently</p>	0=FALSE 1=TRUE	0
P 13	FIXED BOOST MVF	<p>Used to correctly flux the motor at low speeds. This allows the drive to produce greater starting torque for high friction loads. It increases the motor volts above the selected V/F characteristic at the lower end of the speed range</p> <p>OUTPUT VOLTS</p> <p>100% 25% 0%</p> <p>INCREASED TORQUE FLUXING</p> <p>CONSTANT POWER RANGE</p> <p>NORMAL FLUXING</p> <p>INCREASING BOOST</p> <p>f_B → FREQUENCY</p> <p>f_B = BASE FREQUENCY</p>	0.00 to 25.00%	product code dependent
P 99	PASSWORD	A password may be set to prohibit unauthorised adjustment of parameters. When P99 is set to non-zero you will be required to match this value before parameters can be adjusted	0000 – FFFF	0000
<i>Parameters P301 to P308 are visible in the PAR menu when Application 3 is selected in parameter P1</i>				
P 301	PRESET 0	A user-adjustable speed preset, set by potentiometer	-100.00 to 100.00	-
P 302	PRESET 1	A user-adjustable speed preset	-100.00 to 100.00	20.00
P 303	PRESET 2	A user-adjustable speed preset	-100.00 to 100.00	50.00
P 304	PRESET 3	A user-adjustable speed preset	-100.00 to 100.00	100.00
P 305	PRESET 4	A user-adjustable speed preset	-100.00 to 100.00	-10.00
P 306	PRESET 5	A user-adjustable speed preset	-100.00 to 100.00	-20.00
P 307	PRESET 6	A user-adjustable speed preset	-100.00 to 100.00	-50.00
P 308	PRESET 7	A user-adjustable speed preset	-100.00 to 100.00	-100.00
<i>Parameters P401 to P404 are visible in the PAR menu when Application 4 is selected in parameter P1</i>				
P 401	R/L RAMP TIME	The time taken to ramp the Raise/Lower output from 0.00% to 100.00% of its value	0.0 to 600.0s	10.0s
P 402	R/L MAX VALUE	The maximum value for the ramp output	-100.00 to 100.00%	100.00%
P 403	R/L MIN VALUE	The minimum value for the ramp output	-100.00 to 100.00%	0.00%

NORMAL DUTY was previously referred to as Quadratic Torque in past Drives' manuals.

6-4 Programming Your Application

MMI Parameters Table				
Display	Parameter	Description	Range	Default
P 404	R/L RESET VALUE	The value the output is set to when Reset is TRUE, when DIN4 (terminal 10) is 24V in Application 4	-100.00 to 100.00%	0.00%
<i>Parameters ^P501 and ^P506 are visible in the PAR menu when Application 5 is selected in parameter ^P1</i>				
P 501	PI P GAIN	The PI proportional gain	0.00 to 100.00	0.10
P 502	PI I GAIN	The PI integral gain	0.00 to 100.00	1.00
P 503	PID D GAIN	The PID derivative gain	0.00 to 100.00	0.00
P 504	PID D FILTER TC	In order to help attenuate high frequency noise on the derivative term, a first order lag has been provided. This parameter determines the filter time constant.	0.05 to 10.00s	0.05s
P 505	PID FEEDBACK GAIN	A multiplier applied to the feedback signal of the PID	-10.00 to 10.00	1.00
P 506	PID LIMIT	Determines the maximum positive and negative excursion (Limit) of the PID output	0.00 to 300.00%	300.00%
P 507	PID SCALING	This parameter represents an overall scaling factor which is applied after the PID positive and negative limit clamps	-3.0000 to 3.0000	1.0000
P 508	PID ERROR	The result of SETPOINT - FEEDBACK x FEEDBACK GAIN	—.xx %	—.xx%
P 509	PID OUTPUT	The output of the PID function block	—.xx %	—.xx %
<i>Parameters ^P901 and ^P908 are visible in the PAR menu when there are corresponding entries in the CUSTOM MENU block.</i>				
P 901	CUSTOM MENU 1	Select a parameter to be displayed in the PAR Menu by entering the Tag Number for the parameter using DSE (or other suitable programming tool). Eight parameters can be entered into the menu. CUSTOM MENU 1 is the first of the new parameters in the menu, CUSTOM MENU 2 is the second of the new parameters in the menu, and so on. These parameters contained in P901 to P908 will appear at the bottom of the parameter list for the PAR Menu. Enter 0 to leave a position in the menu unused.	0 to 1655	0
P 902	CUSTOM MENU 2	As ^P 901	0 to 1655	0
P 903	CUSTOM MENU 3	As ^P 901	0 to 1655	0
P 904	CUSTOM MENU 4	As ^P 901	0 to 1655	0
P 905	CUSTOM MENU 5	As ^P 901	0 to 1655	0
P 906	CUSTOM MENU 6	As ^P 901	0 to 1655	0
P 907	CUSTOM MENU 7	As ^P 901	0 to 1655	0
P 908	CUSTOM MENU 8	As ^P 901	0 to 1655	0
SET::CTRL Menu				
SCLO1	CONTROL MODE	This parameter contains the main method of motor control used by the drive	0=VOLTS/HZ 1=SENSORLESS VEC	0
SCLO2	NAMEPLATE RPM	This parameter contains the motor nameplate full-load rated speed. This is the motor speed in rpm at base frequency minus full load slip	0.1 to 30000.0 RPM	product code dependent

MMI Parameters Table

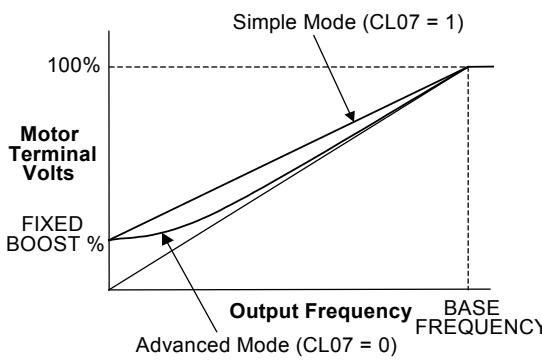
Display	Parameter	Description	Range	Default
5CL03	FLY-CATCH ENABLE VF	Enables flycatching in Volts/Hz control mode when TRUE. Allows the drive to catch a spinning load.	0=FALSE 1=TRUE	0
5CL03	FLY-CATCH ENABLE SV	Enables flycatching in Sensorless Vector control mode when TRUE. Allows the drive to catch a spinning load.	0=FALSE 1=TRUE	0
5CL04	SLIP COMP ENABLE VF	Slip compensation is operational when TRUE. Eliminates motor speed variations under load conditions in V/F Fluxing Mode when the correct value for MAG CURRENT is entered into ⁵ CL14	0=FALSE 1=TRUE	0
5CL05	STABILISATION ENABLE VF	Enables the stabilisation function when TRUE. Eliminates light load speed variations in V/F Fluxing Mode	0=FALSE 1=TRUE	1
5CL06	VOLTAGE CONTROL MODE VF	NONE : no attempt is made to control the PWM modulation depth for variations in dc link voltage FIXED : the drive's output volts are maintained, regardless of variations in the dc link voltage. The drive's product code sets the default value for demanded maximum output voltage (see MOTOR VOLTAGE below) AUTOMATIC : the drive performs controlled over-fluxing during motor deceleration	0=NONE 1=FIXED 2=AUTOMATIC	0
5CL07	BOOST MODE FVF	Determines the relationship between fixed boost and terminal volts. There are two settings: FALSE produces the terminal volts profile shown below (with Auto Boost set to 0.0 %). In this mode AUTO BOOST (CL08) should also be set to provide optimum low speed performance. TRUE emulates the terminal volts profile provided by the 601 product. This allows drop in replacement of the 601 by the 650V. AUTO BOOST (CL08) has no effect in this mode. 	0=FALSE 1=TRUE	0
5CL08	AUTO BOOST F M VF	This parameter allows for load dependent, stator resistance voltage-drop compensation. This correctly fluxes the motor (under load conditions) at low output frequencies, thereby increasing available motor torque.. AUTO BOOST is only used when BOOST MODE is set to 0. The value of the AUTO BOOST parameter determines the level of additional volts supplied to the motor for 100% load. Setting the value of AUTO BOOST too high can cause the drive to enter current limit. If this occurs, the time taken for the drive to reach operating speed will be extended. Reducing the value of AUTO BOOST will eliminate this problem.	0.00 to 25.00 %	0.00 %

6-6 Programming Your Application

MMI Parameters Table				
Display	Parameter	Description	Range	Default
5CL09	ENERGY SAVING FVF	When set TRUE, the demanded volts are reduced to minimise energy consumption if the drive is operating in a steady state at light load.	0=FALSE 1=TRUE	0
5CL10	MOTOR CURRENT MSV	This parameter contains the motor nameplate full-load line current	0.01 to 999.99A	product code dependent
5CL11	MOTOR POLES MSV	This parameter contains the number of motor poles, as supplied on the motor nameplate	2=2 pole 4=4 pole 6=6 pole 8=8 pole 10=10 pole 12=12 pole	1
5CL12	MOTOR VOLTAGE M	This parameter contains the motor nameplate voltage at base frequency	0.0 to 575.0V	product code dependent
5CL14	MAG CURRENT M	This parameter contains the motor model no-load line current as determined by the Autotune, or taken from the motor nameplate	0.01 to 999.99 A	product code dependent
5CL15	POWER MSV	This parameter contains the motor nameplate power.	0.00 to 355.00kW	product code dependent
5CL16	MOTOR CONNECTION MSV	This parameter contains the motor nameplate connection.	0= DELTA 1= STAR	1
5CL17	STATOR RES FMSV	This parameter contains the motor model per-phase stator resistance as determined by Autotune.	0.0000 to 250.0000Ω	product code dependent
5CL18	LEAKAGE INDUC FMSV	This parameter contains the motor model per-phase leakage inductance as determined by Autotune.	0.00 to 300.00mH	product code dependent
5CL19	MUTUAL INDUC FMSV	This parameter contains the motor model per-phase mutual inductance as determined by Autotune.	0.00 to 3000.00mH	product code dependent
5CL1A	ROTOR TIME CONST FMSV	This parameter contains the motor model rotor time constant as determined by Autotune.	10.00 to 3000.00ms	product code dependent
5CL20	AUTOTUNE MODE SV	Selects the Autotune operating mode.	0= STATIONARY 1= ROTATING	0
5CL21	AUTOTUNE ENABLE SV	Determines whether the Autotune sequence is operational or not. The Autotune sequence is operational when set to TRUE and the drive is run	0=FALSE 1=TRUE	0
5CL81	CURRENT LIMIT F	This parameter sets the level of motor current, as a % of MOTOR CURRENT (5CL10) at which the drive begins to take current limit action.	0.00 to 300.00%	300.00%
5CL82	POS TORQUE LIMIT F	This parameter sets the maximum allowed level of positive motor torque.	-500.0 to 500.0%	200.0%
5CL83	NEG TORQUE LIMIT F	This parameter sets the maximum allowed level of negative motor torque.	-500.0 to 500.0%	-200.0%
5CL84	STALL TRIP TYPE F	This parameter determines whether the stall trip operates on motor torque or motor current. FALSE = TORQUE, TRUE = CURRENT	0= FALSE 1= TRUE	1
5CL91	SPEED PROP GAIN FMSV	Sets the proportional gain of the loop. Speed error (revolutions per second) x proportional gain = torque percent.	0.00 to 300.00	product code dependent

MMI Parameters Table				
Display	Parameter	Description	Range	Default
5CL92	SPEED INT TIME FMSV	This is the integral time constant of the speed loop. A speed error which causes the proportional term to produce a torque demand T, will cause the integral term to also ramp up to a torque demand T after a time equal to "speed int time".	1 to 15000ms	product code dependent
5CL93	SPEED POS LIMIT FVS	This sets the upper limit of the speed demand.	-110.00 to 110.00%	110.00%
5CL94	SPEED NEG LIMIT FVS	This sets the lower limit of the speed demand.	-110.00 to 110.00%	-110.00%

SET::IN Menu				
5IP01	DIN 1 INVERT	Inverts the value of the signal, TRUE or FALSE.	0= FALSE 1= TRUE	0
5IP02	DIN 2 INVERT	As ^s IP01	As ^s IP01	0
5IP03	DIN 3 INVERT	As ^s IP01	As ^s IP01	0
5IP04	DIN 4 INVERT	As ^s IP01	As ^s IP01	0
5IP05	DIN 5 INVERT	As ^s IP01	As ^s IP01	1
5IP06	DIN 6 INVERT	As ^s IP01	As ^s IP01	0
5IP07	DIN 7 INVERT	As ^s IP01	As ^s IP01	0
5IP11	AIN 1 SCALE		-300.0 to 300.0%	100.0%
5IP12	AIN 1 OFFSET		-300.0 to 300.0%	0.0%
5IP13	AIN 1 TYPE		0 to 100% of selected TYPE 0= 0-10V 1= 0-5V	0
5IP21	AIN 2 SCALE		-300.0 to 300.0%	100.0%
5IP22	AIN 2 OFFSET		-300.0 to 300.0%	0.0%
5IP23	AIN 2 TYPE		0 to 100% of selected TYPE 0= 0-10V 1= 0-5V 2= 0-20mA 3= 4-20mA	3
5IPd1	DIN 1 VALUE F	The TRUE or FALSE input (after any inversion)	0=FALSE 1=TRUE	0
5IPd2	DIN 2 VALUE F	The TRUE or FALSE input (after any inversion)	0=FALSE 1=TRUE	0
5IPd3	DIN 3 VALUE F	The TRUE or FALSE input (after any inversion)	0=FALSE 1=TRUE	0
5IPd4	DIN 4 VALUE F	The TRUE or FALSE input (after any inversion)	0=FALSE 1=TRUE	0
5IPd5	DIN 5 VALUE F	The TRUE or FALSE input (after any inversion)	0=FALSE 1=TRUE	0
5IPd6	DIN 6 VALUE F	The TRUE or FALSE input (after any inversion)	0=FALSE 1=TRUE	0
5IPd7	DIN 7 VALUE F	The TRUE or FALSE input (after any inversion)	0=FALSE 1=TRUE	0
5IPA1	AIN 1 VALUE F	The input reading with scaling and offset applied	—.x%	—.x%
5IPA2	AIN 2 VALUE F	The input reading with scaling and offset applied	—.x%	—.x%

6-8 Programming Your Application

MMI Parameters Table					
Display	Parameter	Description	Range	Default	
SET::OUT Menu					
50P01	AOUT 1 SOURCE	ANALOG OUTPUT 0 NONE 1 DEMAND % 2 CURRENT % 3 PI ERROR % 4 RAISE/LOWER % OUTPUT	0= NONE 1= DEMAND 2= CURRENT 3= PID ERROR 4= RAISE/LOWER OUTPUT	1	
50P02	AOUT 1 SCALE		-300.00 to 300.00%	100.00%	
50P03	AOUT 1 OFFSET		-300.00 to 300.00%	0.00%	
50P04	AOUT 1 ABSOLUTE		0= FALSE (not absolute) 1= TRUE (absolute)		1
50P05	AOUT 1 VALUE		-300.0 to 300.0%	0.0%	
50P21	DOUT 2 SOURCE		DIN4 / DOUT2 Refer to Configuring Terminals 9 & 10 (Digital Input/Output), page 6-6-13. 0 NONE 1 HEALTH 2 TRIPPED 3 RUNNING 4 AT ZERO 5 AT SPEED 6 AT LOAD	0= NONE 1= HEALTH 2= TRIPPED 3= RUNNING 4= AT ZERO 5= AT SPEED 6= AT LOAD	0
50P22	DOUT 2 INVERT	(OUTPUT) As 50P01. Set to 0 for applications 1 & 5.	As 50P01	0	
50P23	DOUT 2 VALUE	The TRUE or FALSE output demand.	0=FALSE 1=TRUE	0	
50P31	RELAY SOURCE	NONE : Relay is open <i>Relay is closed when:</i> HEALTH : the Run signal is not present, or no trip is active TRIPPED : a trip is present RUNNING : the motor is running AT ZERO : the output frequency is below 1% of MAX SPEED (P2) AT SPEED : the output frequency is at or near Setpoint and within ±1% of MAX SPEED, set by (P2). For example: if MAX SPEED = 50Hz and Setpoint = 30Hz, then 1% of MAX SPEED = 0.5Hz. So AT LOAD is True between 30 ±0.5Hz. AT LOAD : the magnitude of the output torque is greater than or equal to the torque level set in ST42	As 50P21	1	
50P32	RELAY INVERT	RELAY 0 NONE 1 HEALTH 2 TRIPPED 3 RUNNING 4 AT ZERO 5 AT SPEED 6 AT LOAD	INVERT (output 50P32)	0=FALSE 1=TRUE	0
50P33	RELAY VALUE			The TRUE or FALSE output demand.	0=FALSE 1=TRUE

MMI Parameters Table				
Display	Parameter	Description	Range	Default
SET::TRIP Menu				
5LOOP	DISABLE LOOP	Disables LOST I LOOP trip (4-20mA)	0= TRIP ENABLED 1= TRIP DISABLED	1
5t3	AIN2 OVERLOAD	Disables the overload trip (Terminal 3)	As 5LOOP	0
5StLL	DISABLE STALL	Disables STALL trip	As 5LOOP	0
5Ot	DISABLE MOTOR OVERTEMP	Disables the motor thermistor trip	As 5LOOP	0
5It	INVERSE TIME	Disables the inverse time trip	As 5LOOP	1
5db r	DYNAMIC BRAKE RESISTOR	Disables the dynamic brake resistor trip	As 5LOOP	1
5db S	DYNAMIC BRAKE SWITCH	Disables the dynamic brake switch trip	As 5LOOP	1
5SPd	SPEED FEEDBACK	Disables the speed feedback trip	As 5LOOP	0
5QSPd	OVERSPEED	Disables the overspeed trip	As 5LOOP	0
5dI SP	DISPLAY (KEYPAD)	Disables the display (keypad) trip	As 5LOOP	0
5dC r P	DC LINK RIPPLE	Disables the DC link ripple trip	As 5LOOP	0









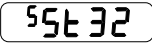
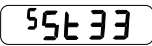
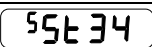
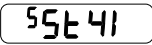
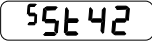
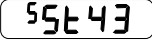

SET::SERL Menu				
5SE01	REMOTE COMMS SEL	Selects the type of remote communications mode: 0 : FALSE, and in REMOTE mode then control is from the terminals. 1 : TRUE, and in REMOTE mode then control is from the communications.	0=FALSE 1=TRUE	0
5SE02	COMMS TIMEOUT	Sets the maximum time allowed between refreshing the COMMS COMMAND parameter. The drive will trip if this time is exceeded. Set the time to 0.00 seconds to disable this feature.	0.0 to 600.0s	0.0s
5SE03	COMMS ADDRESS	The drives identity address. Note: if set to 0, it will only respond to broadcast messages.	0 to 255	0
5SE04	BAUD RATE	Selects the Baud Rate for the MODBUS protocol.	0 : 1200 1 : 2400 2 : 4800 3 : 7200 4 : 9600 5 : 14400 6 : 19200 7 : 38400 8 : 57600	4
5SE05	PARITY	Selects the Parity for the MODBUS protocol.	0= NONE 1= ODD 2= EVEN	0
5SE06	REPLY DELAY ms	The time in milliseconds between the drive receiving the complete request from the communications master (PLC/PC) and replying to this request.	0 to 200	5
5SE07	OP PORT PROTOCOL	Selects the protocol to be used by the keypad port on the front of the drive. When EIBISYNC ASCII is selected, BAUD RATE is 19200 and PARITY is EVEN. FIELDBUS is reserved for future use.	0= AUTOMATIC 1= KEYPAD 2=EIBISYNC ASCII 3= MODBUS 4= FIELDBUS	0

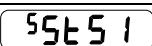
6-10 Programming Your Application

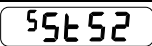
MMI Parameters Table				
Display	Parameter	Description	Range	Default
5SE08	P3 PORT PROTOCOL F	Selects the protocol to be used by the RS232 programming port on the drive's control board. When EIBISYNC ASCII is selected, BAUD RATE is 19200 and PARITY is EVEN. FIELD BUS is reserved for future use.	As 5SE07	0
5SE09	RS485 PROTOCOL F	Selects the protocol to be used by the RS485 programming port on the drive's control board. FIELD BUS is reserved for future use. KEYPAD is not applicable.	As 5SE07	3
5SE10	SWITCH OP PORT F	When TRUE, the keypad port on the front of the drive is disabled when the communications equipment is connected to the RS232 programming port on the drive's control board. When FALSE, the RS485 programming port is disabled when the communications equipment is connected to the RS232 programming port. Both ports are on the drive's control board.	0=FALSE 1=TRUE	0

SET::SETP Menu				
5SE01	JOG ACCEL TIME	As P4, for Jog	0.0 to 3000.0s	1.0
5SE02	JOG DECEL TIME	As P5, for Jog	0.0 to 3000.0s	1.0
5SE03	RAMP TYPE	Selects the ramp type	0=LINEAR 1=S	0
5SE04	S RAMP JERK	Rate of change of acceleration of the curve in units per second ³	0.01 to 100.00 s ³	10.00
5SE05	S RAMP CONTINUOUS	When TRUE and the S ramp is selected, forces a smooth transition if the speed setpoint is changed when ramping. The curve is controlled by the S RAMP JERK parameter. When FALSE, there is an immediate transition from the old curve to the new curve	0=FALSE 1=TRUE	1
5SE06	MIN SPEED MODE	Selects a mode to determine how the drive will follow a reference: Proportional : minimum limit, Linear : between minimum and maximum.	0=PROP.W/MIN. 1=LINEAR (used by the 601 product)	0
5SE11	SKIP FREQUENCY 1	This parameter contains the centre frequency of skip band 1 in Hz	0.0 to 240.0 Hz	0.0
5SE12	SKIP FREQUENCY BAND 1	The width of skip band 1 in Hz	0.0 to 60.0 Hz	0.0
5SE13	SKIP FREQUENCY 2	This parameter contains the centre frequency of skip band 2 in Hz	0.0 to 240.0 Hz	0.0
5SE14	SKIP FREQUENCY BAND 2	The width of skip band 2 in Hz	0.0 to 60.0 Hz	0.0
5SE21	AUTO RESTART ATTEMPTS	Determines the number of restarts that will be permitted before requiring an external fault reset	0 to 10	0
5SE22	AUTO RESTART DELAY	Determines the delay between restart attempts for a trip included in AUTO RESTART TRIGGERS and AUTO RESTART TRIGGERS+. The delay is measured from all error conditions clearing	0.0 to 600.0 s	10.0
5SE23	AUTO RESTART TRIGGERS	Allows Auto Restart to be enabled for a selection of trip conditions. Refer to Chapter 7: "Trips and Fault Finding" - Hexadecimal Representation of Trips	0x0000 to 0xFFFF	0x0000
5SE24	AUTO RESTART TRIGGERS+	Allows Auto Restart to be enabled for a selection of trip conditions. Refer to Chapter 7: "Trips and Fault Finding" - Hexadecimal Representation of Trips	0x0000 to 0xFFFF	0x0000
5SE31	DB ENABLE	Enables operation of the dynamic braking.	0=FALSE 1=TRUE	1

MMI Parameters Table

Display	Parameter	Description	Range	Default	
	DB RESISTANCE	The value of the load resistance.	1 to 1000	product code dependent	
	DB POWER	The power that the load resistance may continually dissipate.	0.1 to 510.0 kW	product code dependent	
	DB OVER-RATING	Multiplier that may be applied to DB POWER for power overloads lasting no more than 1 second.	1 to 40	25	
	TORQUE FEEDBACK	Shows the estimated motor torque, as a percentage of rated motor torque.	—.xx %	—.xx %	
	TORQUE LEVEL	This parameter sets the value of load at which AT LOAD becomes TRUE. AT LOAD may be connected to a digital output. Refer to ^S DOP1 and ^S DOP3. 100% = rated torque for the motor.	-300.0 to 300.0 %	100.0 %	
	USE ABS TORQUE 	When TRUE, the direction of rotation is ignored. In this case, the comparison level should always be positive. When FALSE, the direction of rotation is not ignored. Driving a load in the reverse direction gives a negative value for torque. In this case, the comparison level may be positive or negative.	0=FALSE 1=TRUE	0	
	LOCAL MIN SPEED 	The magnitude of the minimum setpoint that will be used when running in Local Mode.	0.0 to 100.0 %	0.0 %	
	ENABLED KEYS 	The following keys on the 6901 keypad can be enabled or disabled separately. The combination produces the parameter setting as in the table below. The default of FFFF enables all keys.	0000 to FFFF	FFFF	
	Parameter Setting	RUN	L/R	JOG	DIR
	0000	-	-	-	-
	0010	-	-	-	ENABLED
	0020	-	-	ENABLED	-
	0030	-	-	ENABLED	ENABLED
	0040	-	ENABLED	-	-
	0050	-	ENABLED	-	ENABLED
	0060	-	ENABLED	ENABLED	-
	0070	-	ENABLED	ENABLED	ENABLED
	0080	ENABLED	-	-	-
	0090	ENABLED	-	-	ENABLED
	00A0	ENABLED	-	ENABLED	-
	00B0	ENABLED	-	ENABLED	ENABLED
	00C0	ENABLED	ENABLED	-	-
	00D0	ENABLED	ENABLED	-	ENABLED
	00E0	ENABLED	ENABLED	ENABLED	-
	00F0	ENABLED	ENABLED	ENABLED	ENABLED
	6901				
	6911				
	6511				
	6521				
		When using the standard 6511 and 6521 keypad, disabling the DIR key prevents the local setpoint going negative (for reverse). Similarly, disabling the L/R key prevents the drive being changed from Local to Remote, or Remote to Local modes.			

6-12 Programming Your Application

MMI Parameters Table				
Display	Parameter	Description	Range	Default
55t98	APPLICATION LOCK F	Setting this parameter to TRUE prevents editing of parameter P1. Set this parameter to FALSE to edit parameter P1.	0=FALSE 1=TRUE	0
55t99	DETAILED MENUS	Selects Full menu detail when TRUE. The additional parameters in the Full menus are indicated in this table by F	0=FALSE 1=TRUE	0
SET::ENC Menu				
5EN01	ENC MODE F	Set this parameter to the requirements for your encoder: 0 : QUADRATURE (using digital inputs 6 & 7, ENCA and ENCB respectively) 1 : CLOCK/DIR (using digital inputs 6 & 7, ENCA and ENCB respectively) 2 : CLOCK (using digital input 6, ENCA)	0= QUADRATURE 1= CLOCK/DIR 2= CLOCK	0
5EN02	ENC RESET F	When TRUE the POSITION and SPEED outputs are set (and held) at zero.	0=FALSE 1=TRUE	0
5EN03	ENC INVERT F	When TRUE, changes the sign of the measured speed and the direction of the position count.	0=FALSE 1=TRUE	0
5EN04	ENC LINES F	The number of lines must be set to match the type of encoder being used. Incorrect setting of this parameter will result in an erroneous speed measurement.	100 to 10000	100
5EN05	ENC SPEED SCALE F	This parameter allows the output "speed" to be scaled to any value the user requires. With a default value of 1.00, the output "speed" is measured in revs per second. Changing the ENC SPEED SCALE value to 60.00 will provide an output in revs per minute. To provide an output in percent of the motor maximum speed, where maximum speed is the maximum speed your motor will run in rpm, the ENC SPEED SCALE parameter should be set to the result of: $\frac{6000}{\text{maximum speed (rpm)}}$	0.00 to 300.00	1.00
5EN06	ENC SPEED F	Speed feedback, in units defined by the ENC SPEED SCALE parameter.	—.x	—.x

Configuring Terminals 9 & 10 (Digital Input/Output)

Terminal 10 can be operated as digital input DIN 4 or digital output DOUT2. It is configured via the keypad or DSE Lite (or other suitable programming tool). The default for terminal 10 is to operate as a digital input, and the input logic is non-inverted.

Terminal 9 can be operated as digital input DIN3 or digital output DOUT1, however, it can only be configured via DSE Lite (or other suitable programming tool). The default for terminal 9 is to operate as a digital input, and the input logic is non-inverted.

Configure for use as a Digital Input (default)

For example, to use terminal 10 as an input, the output circuitry must be disabled by setting ^SOP21 and ^SOP22 to zero. You can invert this logic using parameter ^SIP04.

Parameter	Setting
^SOP21 DOUT2 SOURCE	0
^SOP22 DOUT2 INVERT	0
^SIP04 DIN4 INVERT	Default is 0, setting to 1 inverts the input logic

Configure for use as a Digital Output

For example, to use terminal 10 as an output, select ^SOP21 to be 1, 2, 3, 4, 5 or 6. For instance, you could set parameter ^SOP21 to 3 to have the output go high (24V) whenever the motor is running, operating an external relay or lamp. You can invert this logic using parameter ^SOP22.

Parameter	Setting
	<i>The output is high when:</i>
	1 = HEALTH The Run signal is not present, or no trip is active
	2 = TRIPPED A trip is present
	3 = RUNNING The motor is running
	4 = AT ZERO The output frequency is below 1% of MAX SPEED (^P 2)
^SOP21 DOUT2 SOURCE	5 = AT SPEED The output frequency is at or near Setpoint and within $\pm 1\%$ of MAX SPEED, set by (^P 2). For example: if MAX SPEED = 50Hz and Setpoint = 30Hz, then 1% of MAX SPEED = 0.5Hz. So AT LOAD is True between 30 ± 0.5 Hz.
	6 = AT LOAD The magnitude of the output torque is greater than or equal to the torque level set in ^S ST42
	Always set ^S IP04 to 0 if using Applications 1 and 5
^SOP22 DOUT2 INVERT	Default is 0, setting to 1 inverts the output logic

6-14 Programming Your Application

PID - Tuning Your Drive

Parameters ^P501 to ^P508: PID is used to control the response of any closed loop system. It is used specifically in system applications involving the control of drives to provide zero steady state error between Setpoint and Feedback, together with good transient performance.

Proportional Gain (^P501)

This is used to adjust the basic response of the closed loop control system. The PI error is multiplied by the Proportional Gain to produce an output.

Integral (^P502)

The Integral term is used to reduce steady state error between the setpoint and feedback values of the PI. If the integral is set to zero, then in most systems there will always be a steady state error.

Derivative (^P503)

This is used to correct for certain types of control loop instability, and therefore improve response. It is sometimes used when heavy or large inertia rolls are being controlled. The derivative term has an associated filter to suppress high frequency signals.

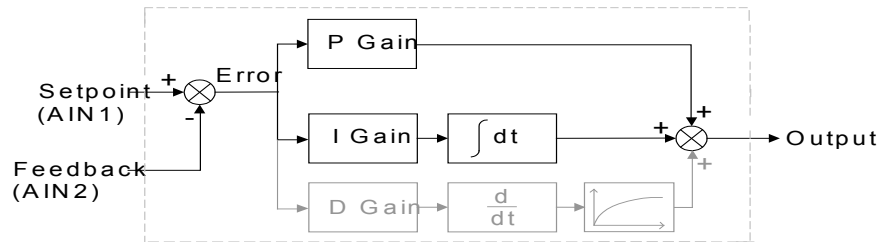

- Functions as P, PI, PID controller
- Single symmetric limit on output

A Method for Setting-up the PI Gains

The gains should be set-up so that a critically damped response is achieved for a step change in setpoint. An underdamped or oscillatory system can be thought of as having too much gain, and an overdamped system has too little.

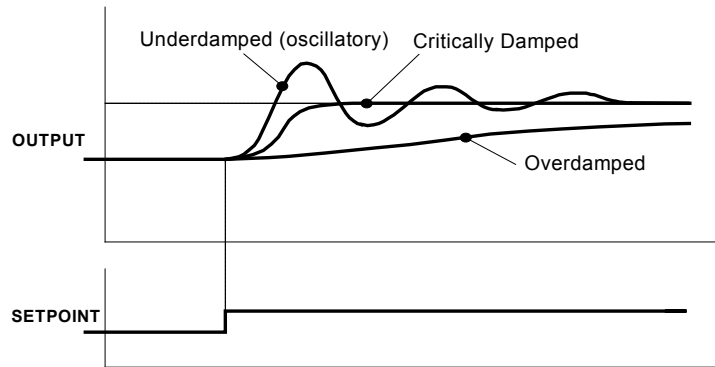

To set up the P gain, set the I gain to zero. Apply a step change in setpoint that is typical for the System, and observe the response. Increase the gain and repeat the test until the system becomes oscillatory. At this point, reduce the P gain until the oscillations disappear. This is the maximum value of P gain achievable.

If a steady state error is present, i.e. the feedback never reaches the setpoint value, the I gain needs to be increased. As before, increase the I gain and apply the step change. Monitor the output. If the output becomes oscillatory, reduce the P gain slightly. This should reduce the steady state error. Increasing the I gain further may reduce the time to achieve zero steady state error.

These values of P and I can now be adjusted to provide the exact response required for this step change.

Auto Restart

Parameters ^SST21 to ^SST24 provide the facility to automatically reset a choice of trip events and restart the drive with a programmed number of attempts. If the drive is not successfully started, a manual or remote trip reset is required.

The number of attempted restarts are recorded. This count is cleared after a trip-free period of operation (5 minutes or 4 x AUTO RESTART DELAY, whichever is the longer); or after a successful manual or remote trip reset; or by removing the Run signal (Terminal 7, DIN1).

Refer to Chapter 7: "Trips and Fault Finding" - Hexadecimal Representation of Trips.

Minimum Speed Mode

There are two operating modes for the minimum speed feature.

Proportional with Minimum

In this mode the speed setpoint is clamped to be between the minimum speed value (P3) and 100%. This is the default for the minimum speed feature.

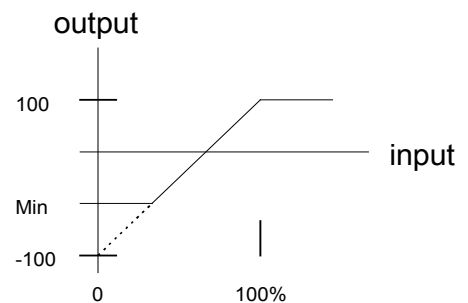

Linear

In this mode the speed setpoint is first clamped to be in the range 0 to 100%. It is then rescaled so that the output goes linearly between the minimum speed value (P3) and 100% for an input setpoint that goes between 0% and 100%. If the minimum speed value (P3) is negative the speed setpoint will be internally set to 0%.

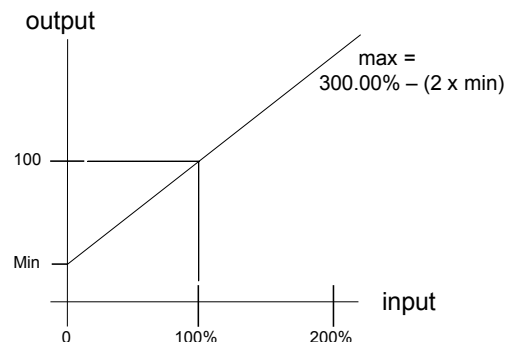

6-16 Programming Your Application

Skip Frequencies

Parameters ^SST11 to ^SST14 control two programmable skip frequencies that can prevent the drive from operating at frequencies that cause mechanical resonance in the load.

- Enter the value of the frequency that causes the resonance into the SKIP FREQUENCY parameter.
- Enter a width for the skip band into the SKIP FREQUENCY BAND parameter.

The drive will then avoid sustained operation within the forbidden band as shown in the diagram. The skip frequencies are symmetrical and thus work in forward and reverse.

Setting SKIP FREQUENCY or SKIP FREQUENCY BAND to 0 disables the corresponding band.

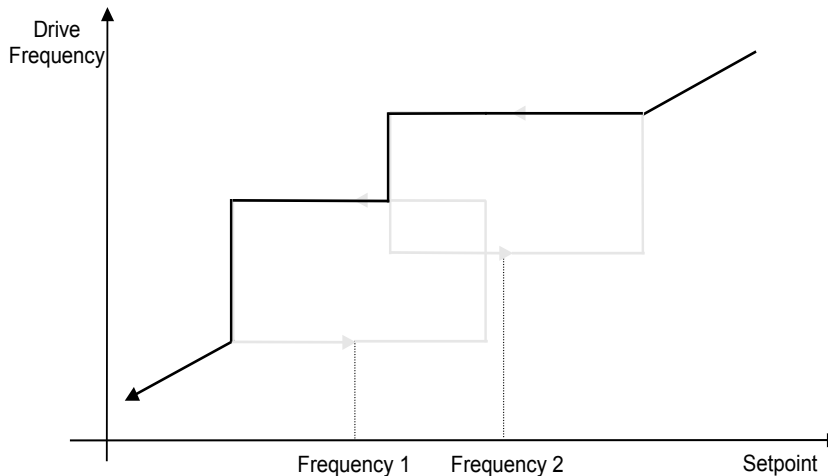
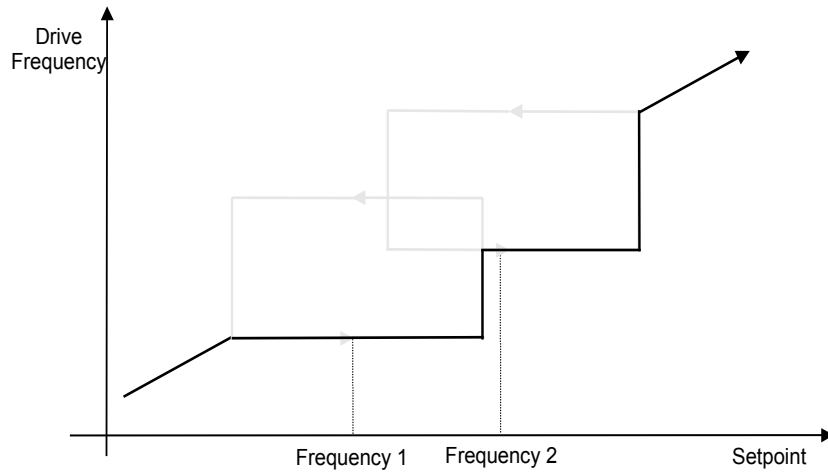
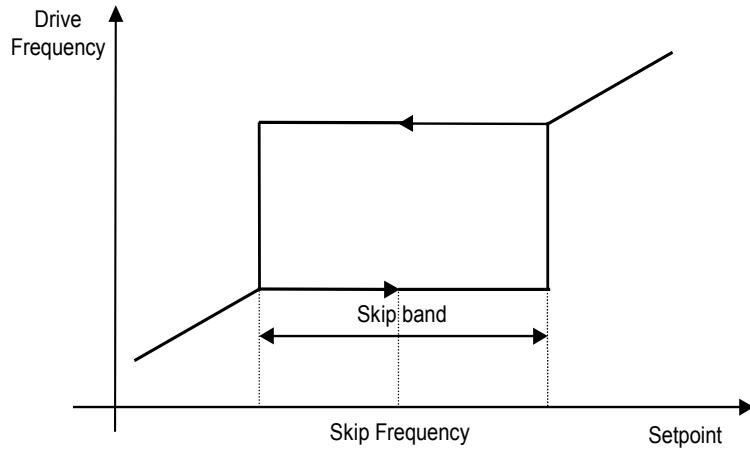

Product-Related Default Values

All examples given in this book are based on a UK, 400V, 50Hz, 11kW drive.

* Frequency Dependent Defaults

These parameter values (marked with "*" in function block descriptions and Application diagrams) are dependent upon the drive's "default frequency".

Changing the "default frequency" parameter from 50Hz to 60Hz, and vice versa, causes the values of the parameters in the table below to be changed.

To change the "default frequency", power-down the drive. Power-up the drive holding down the STOP and "E" keys on the keypad. Release the keys to display the ° 0.01 parameter.

Caution

You are now in a menu containing some sensitive and important parameters.

Press the UP key to display the ° 0.02 parameter. Press the M key. The values for this parameter are: 0 = 50Hz default, 1 = 60Hz default. Select the setting using the UP/DOWN keys and then press the E key. Power-down the drive and power-up again holding down the UP and DOWN keys. This resets **ALL** parameters to their correct default values, including Motor Parameters.

Frequency Dependent Defaults					
Display	Parameter	Function Block	Tag	50Hz Operation	60Hz Operation
P 7	BASE FREQUENCY	MOTOR DATA	1159	50Hz	60Hz
5CL02	NAMEPLATE RPM	MOTOR DATA	83	#	1750 RPM
5CL12	MOTOR VOLTAGE	MOTOR DATA	1160	*	*
P 2	MAX SPEED	REFERENCE	57	50Hz	60Hz
5CL16	MOTOR CONNECTION	MOTOR DATA	124	STAR	STAR
# The correct value is selected for the size of drive - refer to the Power Dependent Parameters table below * The correct value is selected for the drive, however, when 60Hz is selected the 400V unit = 460V					

6-18 Programming Your Application

** Power Dependent Defaults

These parameters (marked with “***” in function block descriptions and Application diagrams) are set to a value depending on the drive's overall “power-build” indicated by the Product Code. We recommend that you do not change the Product Code.

230V Build Power Dependent Defaults			Frame C		Frame D		
Parameter	Function Block	Tag	5.5kW	7.5kW	11kW	15kW	18.5kW
POWER	MOTOR DATA	1158	5.50 kw	7.50 kw	11.00 kw	15.00 kw	18.50 kw
MOTOR CURRENT	MOTOR DATA	64	19.65 A	25.39 A	34.78 A	46.96 A	57.16 A
MAG CURRENT	MOTOR DATA	65	5.90 A	7.62 A	10.43 A	14.09 A	17.15 A
NAMEPLATE RPM	MOTOR DATA	83	1445.0 RPM	1450.0 RPM	1460.0 RPM	1470.0 RPM	1470.0 RPM
MOTOR VOLTAGE	MOTOR DATA	1160	230.0 V	230.0 V	230.0 V	230.0 V	230.0 V
POWER FACTOR	MOTOR DATA	242	0.80	0.83	0.86	0.87	0.87
STATOR RES	MOTOR DATA	119	0.4505 ohms	0.3487 ohms	0.2545 ohms	0.1885 ohms	0.1543 ohms
LEAKAGE INDUC	MOTOR DATA	120	14.34 mH	11.10 mH	8.10 mH	6.00 mH	4.91 mH
MUTUAL INDUC	MOTOR DATA	121	57.36 mH	44.39 mH	32.41 mH	24.00 mH	19.64 mH
ROTOR TIME CONST	MOTOR DATA	1163	276.04 ms	303.65 ms	379.56 ms	506.08 ms	506.08 ms
BRAKE POWER	DYNAMIC BRAKING	78	0.1kw	0.1 kw	0.1 kw	0.1 kw	0.1 kw
FREQUENCY	INJ BRAKING	577	9.0 Hz	9.0 Hz	9.0 Hz	9.0 Hz	9.0 Hz
DEFLUX TIME	INJ BRAKING	710	0.5 s	0.5 s	1.0 s	1.0 s	1.0 s
BASE VOLTS	INJ BRAKING	739	100.00%	100.00%	100.00%	100.00%	100.00%
DC LEVEL	INJ BRAKING	581	2.50%	2.50%	1.80%	1.80%	1.80%
DC PULSE	INJ BRAKING	579	2.0 s	2.0 s	2.0 s	2.0 s	2.0 s
FINAL DC PULSE	INJ BRAKING	580	1.0 s	1.0 s	3.0 s	3.0 s	3.0 s
FIXED BOOST	FLUXING	107	0.00%	0.00%	0.00%	0.00%	0.00%
ACCEL TIME	REFERENCE RAMP	258	10.0 s	10.0 s	10.0 s	10.0 s	10.0 s
DECEL TIME	REFERENCE RAMP	259	10.0 s	10.0 s	10.0 s	10.0 s	10.0 s
DEFLUX DELAY	PATTERN GEN	100	2.0 s	2.0 s	3.0 s	3.0 s	3.0 s
SEARCH VOLTS	FLYCATCHING	573	9.00%	9.00%	9.00%	9.00%	9.00%
SEARCH BOOST	FLYCATCHING	32	40.00%	40.00%	15.00%	15.00%	15.00%
SEARCH TIME	FLYCATCHING	574	10.0 s	10.0 s	15.0 s	15.0 s	15.0 s
REFLUX TIME	FLYCATCHING	709	3.0 s	3.0 s	4.0 s	4.0 s	4.0 s
OVERLOAD	MOTOR DATA	1164	2.0	2.0	2.0	2.0	2.0
SPEED PROP GAIN	SPEED LOOP	1187	20.00	20.00	20.00	20.00	20.00
SPEED INT TIME	SPEED LOOP	1188	100 ms	100 ms	100 ms	100 ms	100 ms
MOTOR CONNECTION	MOTOR DATA	124	1 : STAR	1 : STAR	1 : STAR	1 : STAR	1 : STAR
BRAKE RESISTANCE	DYNAMIC BRAKING	77	100	100	100	100	100
BOOST MODE	FLUXING	1058	0	0	0	0	0

230V Build Power Dependent Defaults			Frame E		Frame F	
Parameter	Function Block	Tag	22kW	30kW	37kW	45kW
POWER	MOTOR DATA	1158	22.00 kw	30.00 kw	37.00 kw	45.00 kw
MOTOR CURRENT	MOTOR DATA	64	65.82 A	93.53 A	114.32 A	136.83 A
MAG CURRENT	MOTOR DATA	65	19.75 A	28.06 A	34.27 A	41.05 A
NAMEPLATE RPM	MOTOR DATA	83	1470.0 RPM	1470.0 RPM	1470.0 RPM	1470.0 RPM
MOTOR VOLTAGE	MOTOR DATA	1160	230.0 V	230.0 V	230.0 V	230.0 V
POWER FACTOR	MOTOR DATA	242	0.87	0.87	0.87	0.87
STATOR RES	MOTOR DATA	119	0.1340 ohms	0.0943 ohms	0.0771 ohms	0.0644 ohms
LEAKAGE INDUC	MOTOR DATA	120	4.26 mH	3.00 mH	4.45 mH	2.05 mH
MUTUAL INDUC	MOTOR DATA	121	17.06 mH	12.00 mH	9.82 mH	8.20 mH
ROTOR TIME CONST	MOTOR DATA	1163	506.08 ms	506.08 ms	506.08 ms	506.08 ms
BRAKE POWER	DYNAMIC BRAKING	78	0.1 kw	0.1 kw	0.1 kw	0.1 kw
FREQUENCY	INJ BRAKING	577	6.0 Hz	6.0 Hz	6.0 Hz	6.0 Hz
DEFLUX TIME	INJ BRAKING	710	1.0 s	2.0 s	2.0 s	2.0 s
BASE VOLTS	INJ BRAKING	739	75.00 %	75.00 %	75.00 %	75.00 %
DC LEVEL	INJ BRAKING	581	1.3 %	1.3 %	1.3 %	1.3 %
DC PULSE	INJ BRAKING	579	2.0 s	2.0 s	2.0 s	2.0 s
FINAL DC PULSE	INJ BRAKING	580	3.0 s	3.0 s	3.0 s	3.0 s
FIXED BOOST	FLUXING	107	0.00%	0.00%	0.00%	0.00%
ACCEL TIME	REFERENCE RAMP	258	20.0 s	30.0 s	30.0 s	30.0 s
DECEL TIME	REFERENCE RAMP	259	20.0 s	30.0 s	30.0 s	30.0 s
DEFLUX DELAY	PATTERN GEN	100	4.0 s	4.0 s	4.0 s	4.0 s
SEARCH VOLTS	FLYCATCHING	573	8.00%	8.00%	8.00%	8.00%
SEARCH BOOST	FLYCATCHING	32	15.00%	15.00%	15.00%	15.00%
SEARCH TIME	FLYCATCHING	574	15.0 s	15.0 s	15.0 s	15.0 s
REFLUX TIME	FLYCATCHING	709	5.0 s	6.0 s	6.0 s	6.0 s
OVERLOAD	MOTOR DATA	1164	2.0	2.2	2.2	2.2
SPEED PROP GAIN	SPEED LOOP	1187	20.00	20.00	20.00	20.00
SPEED INT TIME	SPEED LOOP	1188	100 ms	100 ms	100 ms	100 ms
MOTOR CONNECTION	MOTOR DATA	124	1 : STAR	1 : STAR	1 : STAR	1 : STAR
BRAKE RESISTANCE	DYNAMIC BRAKING	77	100	100	100	100
BOOST MODE	FLUXING	1058	0	0	0	0

6-20 Programming Your Application

400V Build Power Dependent Defaults			Frame C			Frame D			
Parameter	Function Block	Tag	7.5kW	11kW	15kW	15kW	18.5kW	22kW	30kW
POWER	MOTOR DATA	1158	7.50 kw	11.00 kw	15.00 kw	15.00 kw	18.50 kw	22.00 kw	30.00 kw
MOTOR CURRENT	MOTOR DATA	64	14.60A	20.00A	27.00A	27.00A	33.00A	38.00A	54.00A
MAG CURRENT	MOTOR DATA	65	4.38 A	6.00 A	8.10 A	8.10 A	9.90 A	11.40A	16.20A
NAMEPLATE RPM	MOTOR DATA	83	1450.0 RPM	1460.0 RPM	1470.0 RPM	1470.0 RPM	1460.0 RPM	1460.0 RPM	1470.0 RPM
MOTOR VOLTAGE	MOTOR DATA	1160	400.0 V	400.0 V	400.0 V	400.0 V	400.0 V	400.0 V	400.0 V
POWER FACTOR	MOTOR DATA	242	0.83	0.86	0.87	0.87	0.88	0.88	0.86
STATOR RES	MOTOR DATA	119	1.0545 ohms	0.7698 ohms	0.5702 ohms	0.5702 ohms	0.4665 ohms	0.4052 ohms	0.2851 ohms
LEAKAGE INDUC	MOTOR DATA	120	33.57 mH	24.50 mH	18.15 mH	18.15 mH	14.85 mH	12.90 mH	9.08 mH
MUTUAL INDUC	MOTOR DATA	121	134.27 mH	98.01 mH	72.60 mH	72.60 mH	59.40 mH	51.59 mH	36.30 mH
ROTOR TIME CONST	MOTOR DATA	1163	303.65 ms	379.56 ms	506.08 ms	506.08 ms	379.56 ms	379.56 ms	506.08 ms
BRAKE POWER	DYNAMIC BRAKING	78	0.1kw	0.1kw	0.1kw	0.1kw	0.1kw	0.1kw	0.1kw
FREQUENCY	INJ BRAKING	577	9.0 Hz	9.0 Hz	9.0 Hz	9.0 Hz	9.0 Hz	9.0 Hz	9.0 Hz
DEFLUX TIME	INJ BRAKING	710	0.5 s	0.5 s	0.5 s	1.0 s	1.0 s	1.0 s	1.0 s
BASE VOLTS	INJ BRAKING	739	100.00%	100.00%	100.00%	100.00%	100.00%	100.00%	100.00%
DC LEVEL	INJ BRAKING	581	2.50%	2.50%	2.50%	1.80%	1.80%	1.80%	1.80%
DC PULSE	INJ BRAKING	579	2.0 s	2.0 s	2.0 s	2.0 s	2.0 s	2.0 s	2.0 s
FINAL DC PULSE	INJ BRAKING	580	1.0 s	1.0 s	1.0 s	3.0 s	3.0 s	3.0 s	3.0 s
FIXED BOOST	FLUXING	107	0.00%	0.00%	0.00%	0.00%	0.00%	0.00%	0.00%
ACCEL TIME	REFERENCE RAMP	258	10.0 s	10.0 s	10.0 s	10.0 s	10.0 s	10.0 s	10.0 s
DECEL TIME	REFERENCE RAMP	259	10.0 s	10.0 s	10.0 s	10.0 s	10.0 s	10.0 s	10.0 s
DEFLUX DELAY	PATTERN GEN	100	2.0 s	2.0 s	2.0 s	3.0 s	3.0 s	3.0 s	3.0 s
SEARCH VOLTS	FLYCATCHING	573	9.00%	9.00%	9.00%	9.00%	9.00%	9.00%	9.00%
SEARCH BOOST	FLYCATCHING	32	40.00%	40.00%	40.00%	15.00%	15.00%	15.00%	15.00%
SEARCH TIME	FLYCATCHING	574	10.0 s	10.0 s	10.0 s	15.0 s	15.0 s	15.0 s	15.0 s
REFLUX TIME	FLYCATCHING	709	3.0 s	3.0 s	3.0 s	4.0 s	4.0 s	4.0 s	4.0 s
OVERLOAD	MOTOR DATA	1164	2.0	2.0	2.0	2.0	2.0	2.0	2.0
SPEED PROP GAIN	SPEED LOOP	1187	20.00	20.00	20.00	20.00	20.00	20.00	20.00
SPEED INT TIME	SPEED LOOP	1188	100 ms	100 ms	100 ms	100 ms	100 ms	100 ms	100 ms
MOTOR CONNECTION	MOTOR DATA	124	1 : STAR	1 : STAR	1 : STAR	1 : STAR	1 : STAR	1 : STAR	1 : STAR
BRAKE RESISTANCE	DYNAMIC BRAKING	77	100	100	100	100	100	100	100
BOOST MODE	FLUXING	1058	0	0	0	0	0	0	0

Programming Your Application 6-21

Parameter	Function Block	Tag	Frame E			Frame F		
			30kW	37kW	45kW	55kW	75kW	90kW
POWER	MOTOR DATA	1158	30.00 kw	37.00 kw	45.00 kw	55.00 kw	75.00 kw	90.00 kw
MOTOR CURRENT	MOTOR DATA	64	54.00A	66.00 A	79.00 A	97.00 A	132.00 A	151.00 A
MAG CURRENT	MOTOR DATA	65	16.20A	19.80 A	23.70 A	29.10 A	39.60 A	45.30 A
NAMEPLATE RPM	MOTOR DATA	83	1470.0 RPM	1470.0 RPM	1470.0 RPM	1475.0 RPM	1475.0 RPM	1480.0 RPM
MOTOR VOLTAGE	MOTOR DATA	1160	400.0 V	400.0 V	400.0 V	400.0 V	400.0 V	400.0 V
POWER FACTOR	MOTOR DATA	242	0.86	0.85	0.87	0.86	0.87	0.90
STATOR RES	MOTOR DATA	119	0.2851 ohms	0.2333 ohms	0.1949 ohms	0.1587 ohms	0.1166 ohms	0.1020 ohms
LEAKAGE INDUC	MOTOR DATA	120	9.08 mH	7.43 mH	6.20 mH	5.05 mH	3.71 mH	3.25 mH
MUTUAL INDUC	MOTOR DATA	121	36.30 mH	29.70 mH	24.81 mH	20.21 mH	14.85 mH	12.98 mH
ROTOR TIME CONST	MOTOR DATA	1163	506.08 ms	506.08 ms	506.08 ms	607.30 ms	607.30 ms	759.12 ms
BRAKE POWER	DYNAMIC BRAKING	78	0.1kw	0.1 kw	0.1 kw	0.1 kw	0.1 kw	0.1 kw
FREQUENCY	INJ BRAKING	577	6.0 Hz	6.0 Hz	6.0 Hz	6.0 Hz	6.0 Hz	6.0 Hz
DEFLUX TIME	INJ BRAKING	710	1.0 s	1.0 s	1.0 s	2.0 s	2.0 s	2.0 s
BASE VOLTS	INJ BRAKING	739	75.00%	75.00%	75.00%	75.00%	75.00%	75.00%
DC LEVEL	INJ BRAKING	581	1.30%	1.30%	1.30%	1.30%	1.30%	1.30%
DC PULSE	INJ BRAKING	579	2.0 s	2.0 s	2.0 s	2.0 s	2.0 s	2.0 s
FINAL DC PULSE	INJ BRAKING	580	3.0 s	3.0 s	3.0 s	3.0 s	3.0 s	3.0 s
FIXED BOOST	FLUXING	107	0.00%	0.00%	0.00%	0.00%	0.00%	0.00%
ACCEL TIME	REFERENCE RAMP	258	20.0 s	20.0 s	20.0 s	30.0 s	30.0 s	30.0 s
DECEL TIME	REFERENCE RAMP	259	20.0 s	20.0 s	20.0 s	30.0 s	30.0 s	30.0 s
DEFLUX DELAY	PATTERN GEN	100	4.0 s	4.0 s	4.0 s	4.0 s	4.0 s	4.0 s
SEARCH VOLTS	FLYCATCHING	573	8.00%	8.00%	8.00%	8.00%	8.00%	8.00%
SEARCH BOOST	FLYCATCHING	32	15.00%	15.00%	15.00%	15.00%	15.00%	15.00%
SEARCH TIME	FLYCATCHING	574	15.0 s	15.0 s	15.0 s	15.0 s	15.0 s	15.0 s
REFLUX TIME	FLYCATCHING	709	5.0 s	5.0 s	5.0 s	6.0 s	6.0 s	6.0 s
OVERLOAD	MOTOR DATA	1164	2.0	2.0	2.0	2.2	2.2	2.2
SPEED PROP GAIN	SPEED LOOP	1187	20.00	20.00	20.00	20.00	20.00	20.00
SPEED INT TIME	SPEED LOOP	1188	100 ms	100 ms	100 ms	100 ms	100 ms	100 ms
MOTOR CONNECTION	MOTOR DATA	124	1 : STAR	1 : STAR	1 : STAR	1 : STAR	1 : STAR	1 : STAR
BRAKE RESISTANCE	DYNAMIC BRAKING	77	100	100	100	100	100	100
BOOST MODE	FLUXING	1058	0	0	0	0	0	0

6-22 Programming Your Application

460V Build Power Dependent Defaults (US)							
			Frame C			Frame D	
Parameter	Function Block	Tag	10HP	15HP	20HP	30HP	40HP
POWER	MOTOR DATA	1158	7.50 kw	11.00 kw	15.00 kw	22.00 kw	30.00 kw
MOTOR CURRENT	MOTOR DATA	64	14.00 A	20.00 A	27.00 A	38.00 A	52.00 A
MAG CURRENT	MOTOR DATA	65	4.38 A	6.00 A	8.10 A	11.40 A	16.20 A
NAMEPLATE RPM	MOTOR DATA	83	1750.0 RPM	1750.0 RPM	1750.0 RPM	1750.0 RPM	1750.0 RPM
MOTOR VOLTAGE	MOTOR DATA	1160	460.0 V	460.0 V	460.0 V	460.0 V	460.0 V
POWER FACTOR	MOTOR DATA	242	0.83	0.86	0.87	0.88	0.86
STATOR RES	MOTOR DATA	119	1.0545 ohms	0.7698 ohms	0.5702 ohms	0.4052 ohms	0.2851 ohms
LEAKAGE INDUC	MOTOR DATA	120	33.57 mH	24.50 mH	18.15 mH	12.90 mH	9.08 mH
MUTUAL INDUC	MOTOR DATA	121	134.27 mH	98.01 mH	72.60 mH	51.59 mH	36.30 mH
ROTOR TIME CONST	MOTOR DATA	1163	303.65 ms	379.56 ms	506.08 ms	379.56 ms	506.08 ms
BRAKE POWER	DYNAMIC BRAKING	78	0.1 kw	0.1 kw	0.1 kw	0.1 kw	0.1 kw
FREQUENCY	INJ BRAKING	577	9.0 Hz	9.0 Hz	9.0 Hz	9.0 Hz	9.0 Hz
DEFLUX TIME	INJ BRAKING	710	0.5 s	0.5 s	0.5 s	1.0 s	1.0 s
BASE VOLTS	INJ BRAKING	739	100.00%	100.00%	100.00%	100.00%	100.00%
DC LEVEL	INJ BRAKING	581	2.50%	2.50%	2.50%	1.80%	1.80%
DC PULSE	INJ BRAKING	579	2.0 s	2.0 s	2.0 s	2.0 s	2.0 s
FINAL DC PULSE	INJ BRAKING	580	1.0 s	1.0 s	1.0 s	3.0 s	3.0 s
FIXED BOOST	FLUXING	107	0.00%	0.00%	0.00%	0.00%	0.00%
ACCEL TIME	REFERENCE RAMP	258	10.0 s	10.0 s	10.0 s	10.0 s	10.0 s
DECEL TIME	REFERENCE RAMP	259	10.0 s	10.0 s	10.0 s	10.0 s	10.0 s
DEFLUX DELAY	PATTERN GEN	100	2.0 s	2.0 s	2.0 s	3.0 s	3.0 s
SEARCH VOLTS	FLYCATCHING	573	9.00%	9.00%	9.00%	9.00%	9.00%
SEARCH BOOST	FLYCATCHING	32	40.00%	40.00%	40.00%	15.00%	15.00%
SEARCH TIME	FLYCATCHING	574	10.0 s	10.0 s	10.0 s	15.0 s	15.0 s
REFLUX TIME	FLYCATCHING	709	3.0 s	3.0 s	3.0 s	4.0 s	4.0 s
OVERLOAD	MOTOR DATA	1164	2.0	2.0	2.0	2.0	2.0
SPEED PROP GAIN	SPEED LOOP	1187	20.00	20.00	20.00	20.00	20.00
SPEED INT TIME	SPEED LOOP	1188	100 ms	100 ms	100 ms	100 ms	100 ms
MOTOR CONNECTION	MOTOR DATA	124	1 : STAR	1 : STAR	1 : STAR	1 : STAR	1 : STAR
BRAKE RESISTANCE	DYNAMIC BRAKING	77	100	100	100	100	100
BOOST MODE	FLUXING	1058	0	0	0	0	0

460V Build Power Dependent Defaults (US)			Frame F			
Parameter	Function Block	Tag	75HP	100HP	125HP	150HP
POWER	MOTOR DATA	1158	55.00 kw	75.00 kw	90.00 kw	90.00 kw
MOTOR CURRENT	MOTOR DATA	64	97.00 A	130.00 A	151.00 A	151.00 A
MAG CURRENT	MOTOR DATA	65	29.10 A	39.60 A	45.30 A	45.30 A
NAMEPLATE RPM	MOTOR DATA	83	1750.0 RPM	1750.0 RPM	1750.0 RPM	1750.0 RPM
MOTOR VOLTAGE	MOTOR DATA	1160	460.0 V	460.0 V	460.0 V	460.0 V
POWER FACTOR	MOTOR DATA	242	0.86	0.87	0.9	0.9
STATOR RES	MOTOR DATA	119	0.1587 ohms	0.1166 ohms	0.1020 ohms	0.1020 ohms
LEAKAGE INDUC	MOTOR DATA	120	5.05 mH	3.71 mH	3.25 mH	3.25 mH
MUTUAL INDUC	MOTOR DATA	121	20.21 mH	14.85 mH	12.98 mH	12.98 mH
ROTOR TIME CONST	MOTOR DATA	1163	607.30 ms	607.30 ms	759.12 ms	759.12 ms
BRAKE POWER	DYNAMIC BRAKING	78	0.1 kw	0.1 kw	0.1 kw	0.1 kw
FREQUENCY	INJ BRAKING	577	6.0 Hz	6.0 Hz	6.0 Hz	6.0 Hz
DEFLUX TIME	INJ BRAKING	710	2.0 s	2.0 s	2.0 s	2.0 s
BASE VOLTS	INJ BRAKING	739	75.00%	75.00%	75.00%	75.00%
DC LEVEL	INJ BRAKING	581	1.30%	1.30%	1.30%	1.30%
DC PULSE	INJ BRAKING	579	2.0 s	2.0 s	2.0 s	2.0 s
FINAL DC PULSE	INJ BRAKING	580	3.0 s	3.0 s	3.0 s	3.0 s
FIXED BOOST	FLUXING	107	0.00%	0.00%	0.00%	0.00%
ACCEL TIME	REFERENCE RAMP	258	30.0 s	30.0 s	30.0 s	30.0 s
DECEL TIME	REFERENCE RAMP	259	30.0 s	30.0 s	30.0 s	30.0 s
DEFLUX DELAY	PATTERN GEN	100	4.0 s	4.0 s	4.0 s	4.0 s
SEARCH VOLTS	FLYCATCHING	573	8.00%	8.00%	8.00%	8.00%
SEARCH BOOST	FLYCATCHING	32	15.00%	15.00%	15.00%	15.00%
SEARCH TIME	FLYCATCHING	574	15.0 s	15.0 s	15.0 s	15.0 s
REFLUX TIME	FLYCATCHING	709	6.0 s	6.0 s	6.0 s	6.0 s
OVERLOAD	MOTOR DATA	1164	2.2	2.2	2.2	2.2
SPEED PROP GAIN	SPEED LOOP	1187	20.00	20.00	20.00	20.00
SPEED INT TIME	SPEED LOOP	1188	100 ms	100 ms	100 ms	100 ms
MOTOR CONNECTION	MOTOR DATA	124	1 : STAR	1 : STAR	1 : STAR	1 : STAR
BRAKE RESISTANCE	DYNAMIC BRAKING	77	100	100	100	100
BOOST MODE	FLUXING	1058	0	0	0	0

6-24 Programming Your Application

7-1 Trips and Fault Finding

Chapter 7

TRIPS AND FAULT FINDING

Trips

Trip Warning Message

The trip display message is flashed repeatedly on the screen to warn of an imminent trip. Some trip conditions need time to take effect. The warning can allow you time to rectify the situation.

The message will clear when you use the keypad, but after a short time will reappear until the problem is resolved, or the drive trips.

What Happens when a Trip Occurs

When a trip occurs, the drive's power stage is immediately disabled causing the motor and load to coast to a stop. The trip is latched until action is taken to reset it. This ensures that trips due to transient conditions are captured and the drive is disabled, even when the original cause of the trip is no longer present.

Keypad Indications

If a trip condition is detected the activated alarm is displayed on the MMI display.

Resetting a Trip Condition

All trips must be reset before the drive can be re-enabled. A trip can only be reset once the trip condition is no longer active, i.e. a trip due to a heatsink over-temperature will not reset until the temperature is below the trip level.

You can reset the trip as follows:



1. Press the  (STOP) key to reset the trip and clear the alarm from the display.
2. Remove and then re-apply the RUN command and the drive will run normally.







In remote mode, success is indicated by displaying **rdy**.

Using the Keypad to Manage Trips

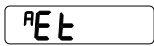
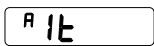
Trip Messages

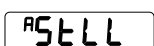

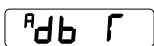
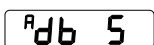
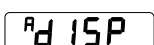
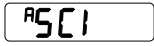
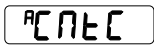
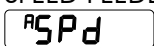



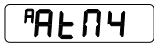
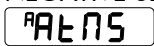
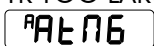

If the drive trips, then the display immediately shows a message indicating the reason for the trip. The possible trip messages are given in the table below.

ID	Trip Name	Possible Reason for Trip
1	OVERVOLTAGE 	<i>The drive internal dc link voltage is too high:</i> <ul style="list-style-type: none">• The supply voltage is too high• Trying to decelerate a large inertia load too quickly; DECEL TIME time too short• The brake resistor is open circuit
2	UNDERVOLTAGE 	<i>DC link low trip:</i> Supply is too low/power down
3	OVERCURRENT 	<i>The motor current being drawn from the drive is too high:</i> <ul style="list-style-type: none">• Trying to accelerate a large inertia load too quickly; ACCEL TIME time too short• Trying to decelerate a large inertia load too quickly; DECEL TIME time too short• Application of shock load to motor• Short circuit between motor phases• Short circuit between motor phase and earth• Motor output cables too long or too many parallel motors connected to the drive• FIXED BOOST level set too high

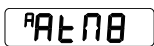
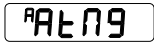
ID	Trip Name	Possible Reason for Trip
4	HEATSINK 	<i>Drive heatsink temperature > 100°C:</i> <ul style="list-style-type: none"> The ambient air temperature is too high Poor ventilation or spacing between drives
5	EXTERNAL TRIP 	<i>The external trip input is high:</i> <ul style="list-style-type: none"> Check configuration to identify the source of the signal (non-standard configuration)
6	INVERSE TIME 	<i>A prolonged overload condition, exceeding the Inverse Time allowance, has caused the trip:</i> <ul style="list-style-type: none"> Remove the overload condition - refer to Chapter 6: P12
7	CURRENT LOOP 	<i>A current of less than 1mA is present when 4-20mA setpoint is selected:</i> <ul style="list-style-type: none"> Look for a wire break
8	MOTOR STALLED 	<i>The motor has stalled (not rotating) Drive in current limit >200 seconds:</i> <ul style="list-style-type: none"> Motor loading too great FIXED BOOST level set too high
9	ANIN FAULT 	<i>AIN2 overload on terminal 3:</i> <ul style="list-style-type: none"> Overcurrent applied in Current mode to terminal 3
10	BRAKE RESISTOR 	<i>External dynamic brake resistor has been overloaded:</i> <ul style="list-style-type: none"> Trying to decelerate a large inertia too quickly or too often
11	BRAKE SWITCH 	<i>Internal dynamic braking switch has been overloaded:</i> <ul style="list-style-type: none"> Trying to decelerate a large inertia too quickly or too often
12	DISPLAY/KEYPAD 	<i>Keypad has been disconnected from drive whilst drive is running in Local Control:</i> <ul style="list-style-type: none"> Keypad accidentally disconnected from drive (indicated over Comms, or by second keypad)
13	LOST COMMS 	<i>Lost communications:</i> <ul style="list-style-type: none"> COMMS TIMEOUT parameter set too short Master device failed Wiring broken Incorrect Comms setup
14	CONTACTOR FBK 	<i>Contactor feedback signal lost:</i> <ul style="list-style-type: none"> Check connection to the terminal wired to "contactor closed" parameter in Sequencing Logic (non-standard configuration)
15	SPEED FEEDBACK 	<i>Speed feedback:</i> <ul style="list-style-type: none"> SPEED ERROR > 50.00% for 10 seconds
16	AMBIENT TEMP 	<i>Ambient temperature:</i> <ul style="list-style-type: none"> The ambient temperature in the drive is too high
17	MOTOR OVERTEMP 	<i>The motor temperature is too high:</i> <ul style="list-style-type: none"> Excessive load Motor voltage rating incorrect FIXED BOOST level set too high Prolonged operation of the motor at low speed without forced cooling Break in motor thermistor connection

7-3 Trips and Fault Finding

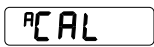
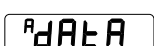
ID	Trip Name	Possible Reason for Trip
18	CURRENT LIMIT A I H I	<i>Software overcurrent trip:</i> <ul style="list-style-type: none"> If the current exceeds 180% of stack rated current for a period of 1 second, the drive will trip. This is caused by shock loads. Remove the shock load. ACCEL TIME and/or FIXED BOOST set too high DECEL TIME set too low
20	24V FAILURE A t 6	<i>24V failure on terminal 6:</i> <ul style="list-style-type: none"> Output overload (warning only). 150mA maximum either individually or as the sum of terminals 6 & 10
21	LOW SPEED OVER I A L S P d	<i>The motor is drawing too much current (> 100%) at zero output frequency:</i> <ul style="list-style-type: none"> FIXED BOOST level set too high
22	10V FAULT A t 4	<i>10V fault:</i> <ul style="list-style-type: none"> +10V REF overload warning (terminal 4) - 10mA maximum
24	DESAT (OVER I) A S H t e	<i>Desaturation:</i> <ul style="list-style-type: none"> Instantaneous overcurrent. Refer to OVERCURRENT in this table.
25	DC LINK RIPPLE A d C r P	<i>The dc link ripple voltage is too high:</i> <ul style="list-style-type: none"> Check for a missing input phase
26	BRAKE SHORT CCT A d b S C	<i>Brake resistor overcurrent:</i> <ul style="list-style-type: none"> Check brake resistor value is greater than minimum allowed
27	OVERSPEED A O S P d	<i>Overspeed:</i> <ul style="list-style-type: none"> > 150% base speed when in Sensorless Vector mode
28	ANOUT FAULT A t 5	<i>AOUT overload on terminal 5:</i> <ul style="list-style-type: none"> 10mA maximum
29	DIGIO 1 (T9) FAULT A t 9	<i>DIN3 overload on terminal 9:</i> <ul style="list-style-type: none"> 20mA maximum
30	DIGIO 2 (T10) FAULT A t 10	<i>DOUT2 overload on terminal 10:</i> <ul style="list-style-type: none"> 150mA maximum either individually or as the sum of terminals 6 & 10
31	UNKNOWN A t r I P	Unknown trip
32	OTHER A t r 3 2	"OTHER" trip is active (Trip ID 34 to 44 inclusive)
34	MAX SPEED LOW A t e n 1	During Autotune the motor is required to run at the nameplate speed of the motor. If MAX SPEED RPM limits the speed to less than this value, an error will be reported. Increase the value of MAX SPEED RPM up to the nameplate rpm of the motor (as a minimum). It may be reduced, if required, after the Autotune is complete.
35	MAIN VOLTS LOW A t e n 2	The mains input voltage is not sufficient to carry out the Autotune. Re-try when the mains has recovered.
36	NOT AT SPEED A t e n 3	The motor was unable to reach the required speed to carry out the Autotune. Possible reasons include: <ul style="list-style-type: none"> motor shaft not free to turn the motor data is incorrect

ID	Trip Name	Possible Reason for Trip
37	MAG CURRENT FAIL 	It was not possible to find a suitable value of magnetising current to achieve the required operating condition for the motor. Check the motor data is correct, especially nameplate rpm and motor volts. Also check that the motor is correctly rated for the drive.
38	NEGATIVE SLIP F 	Autotune has calculated a negative slip frequency, which is not valid. Nameplate rpm may have been set to a value higher than the base speed of the motor. Check nameplate rpm, base frequency, and pole pairs are correct.
39	TR TOO LARGE 	The calculated value of rotor time constant is too large. Check the value of nameplate rpm.
40	TR TOO SMALL 	The calculated value of rotor time constant is too small. Check the value of nameplate rpm.
41	MAX RPM DATA ERR 	This error is reported when the MAX SPEED RPM is set to a value outside the range for which Autotune has gathered data. Autotune gathers data on the motor characteristics up to 30% beyond "max speed rpm". If MAX SPEED RPM is later increased beyond this range, the drive had no data for this new operating area, and so will report an error. To run the motor beyond this point it is necessary to re-autotune with MAX SPEED RPM set to a higher value.
42	LEAKGE L TIMEOUT 	The motor must be stationary when starting the Autotune
43	MOTOR TURNING ERR 	The motor must be able to rotate during Autotune
44	MOTOR STALL ERR 	The leakage inductance measurement requires a test current to be inserted into the motor. It has not been possible to achieve the required level of current. Check that the motor is wired correctly.
-	Product Code Error 	Switch unit off/on. If persistent, return unit to factory
-	Calibration Data Error 	Switch unit off/on. If persistent, return unit to factory
-	Configuration Data Error 	Press the  key to accept the default configuration. If persistent, return unit to factory

7-5 Trips and Fault Finding

Hexadecimal Representation of Trips

The tables below show the possible parameter values for the AUTO RESTART TRIGGERS and AUTO RESTART TRIGGERS+ parameters, ^SST23 and ^SST24 respectively. Refer to the 650V Software Product Manual, "Trips Status" (on our website: www.parker.com/ssd) for additional trip information that is available over the Comms.

Each trip has a unique, four-digit hexadecimal number as shown in the tables below.

^SST23 : AUTO RESTART TRIGGERS				
ID	Trip Name (MMI 6901)	Trip Name (MMI 6511 & 6521)	Mask	User Disable
1	OVERVOLTAGE	DCHI	0x0001	
2	UNDERVOLTAGE	DCLO	0x0002	
3	OVERCURRENT	OC	0x0004	
4	HEATSINK	HOT	0x0008	
5	EXTERNAL TRIP	ET	0x0010	✓
6	INVERSE TIME	<input type="text" value="51t"/>	0x0020	✓
7	CURRENT LOOP	<input type="text" value="5LOOP"/>	0x0040	✓
8	MOTOR STALLED	<input type="text" value="5StLL"/>	0x0080	✓
9	ANIN FAULT	<input type="text" value="5t3"/>	0x0100	✓
10	BRAKE RESISTOR	<input type="text" value="5dbf"/>	0x0200	✓
11	BRAKE SWITCH	<input type="text" value="5db5"/>	0x0400	✓
12	DISPLAY/KEYPAD	<input type="text" value="5dl5P"/>	0x0800	✓
13	LOST COMMS	SCI	0x1000	✓
14	CONTACTOR FBK	CNTC	0x2000	✓
15	SPEED FEEDBACK	<input type="text" value="5SPd"/>	0x4000	✓
16	AMBIENT TEMP	AOT	0x8000	

^SST24 : AUTO RESTART TRIGGERS+				
ID	Trip Name (MMI 6901)	Trip Name (MMI 6511 & 6521)	Mask +	User Disable
17	MOTOR OVERTEMP	<input type="text" value="50t"/>	0x0001	✓
18	CURRENT LIMIT	I HI	0x0002	✓
20	24V FAILURE	T 6	0x0008	✓
21	LOW SPEED OVER I	LSPD	0x0010	
22	10V FAULT	T 4	0x0020	✓
24	DESAT (OVER I)	SHRT	0x0080	
25	DC LINK RIPPLE	DCRP	0x0100	✓
26	BRAKE SHORT CCT	DBSC	0x0200	
27	OVERSPEED	<input type="text" value="5OSPd"/>	0x0400	✓
28	ANOUT FAULT	T 5	0x0800	✓
29	DIGIO 1 (T9) FAULT	T 9	0x1000	✓
30	DIGIO 2 (T10) FAULT	T 10	0x2000	✓
31	UNKNOWN	TRIP	0x4000	
32	OTHER	TR32	0x8000	
34	MAX SPEED LOW	ATN1	0x8000	N/A
35	MAIN VOLTS LOW	ATN2	0x8000	N/A
36	NOT AT SPEED	ATN3	0x8000	N/A
37	MAG CURRENT FAIL	ATN4	0x8000	N/A
38	NEGATIVE SLIP F	ATN5	0x8000	N/A
39	TR TOO LARGE	ATN6	0x8000	N/A
40	TR TOO SMALL	ATN7	0x8000	N/A

ST24 : AUTO RESTART TRIGGERS+				
ID	Trip Name (MMI 6901)	Trip Name (MMI 6511 & 6521)	Mask +	User Disable
41	MAX RPM DATA ERR	ATN8	0x8000	N/A
42	LEAKGE L TIMEOUT	ATN9	0x8000	N/A
43	MOTOR TURNING ERR	ATNA	0x8000	N/A
44	MOTOR STALL ERR	ATNB	0x8000	N/A

Keypads (MMIs):

Trips shown as MMI displays in the tables above, i.e. SLOOP, can be disabled using the keypads in the TRIPS menu. Other trips, as indicated, can be disabled over the Comms.



6901



6511



6521



6911

Hexadecimal Representation of Trips

When more than one trip is to be represented at the same time then the trip codes are simply added together to form the value displayed. Within each digit, values between 10 and 15 are displayed as letters A to F

For example referring to the tables above, if the AUTO RESTART TRIGGERS parameter is set to **03A0**, then this represents:

- a "3" in digit 3
- an "8" and a "2" in digit 2
(8+2 = 10, displayed as A)
- an "0" in digit 1

Decimal number	Display
10	A
11	B
12	C
13	D
14	E
15	F

This in turn represents the trips BRAKE RESISTOR, ANIN FAULT, MOTOR STALLED and INVERSE TIME.

In the same way, the AUTO RESTART TRIGGERS+ parameter set to **03A0** would represent BRAKE SHORT CCT, ANIN FAULT, DESAT OVER I and 10V FAULT.

Fault Finding

Problem	Possible Cause	Remedy
Drive will not power-up	Fuse blown	Check supply details, fit correct fuse. Check Product Code against Model No.
	Faulty cabling	Check all connections are correct/secure. Check cable continuity
Drive fuse keeps blowing	Faulty cabling or connections wrong	Check for problem and rectify before replacing with correct fuse
	Faulty drive	Contact Parker
Cannot obtain power-on state	Incorrect or no supply available	Check supply details
Motor will not run at switch-on	Motor jammed	Stop the drive and clear the jam
Motor runs and stops	Motor becomes jammed	Stop the drive and clear the jam
	Open circuit speed reference potentiometer	Check terminal

8-1 Routine Maintenance and Repair

Chapter 8 ROUTINE MAINTENANCE AND REPAIR

Routine Maintenance

Periodically inspect the drive for build-up of dust or obstructions that may affect ventilation of the unit. Remove this using dry air.

Repair

There are no user-serviceable components.

IMPORTANT: MAKE NO ATTEMPT TO REPAIR THE UNIT - RETURN IT TO PARKER SSD DRIVES.

Saving Your Application Data

In the event of a repair, application data will be saved whenever possible. However, we advise you to copy your application settings before returning the unit.

Returning the Unit to Parker SSD Drives

Please have the following information available:

- The model and serial number - see the unit's rating label
- Details of the fault

Contact your nearest Parker SSD Drives Service Centre to arrange return of the item.

You will be given a *Returned Material Authorisation*. Use this as a reference on all paperwork you return with the faulty item. Pack and despatch the item in the original packing materials; or at least an anti-static enclosure. Do not allow packaging chips to enter the unit.

Disposal

This product contains materials which are consignable waste under the Special Waste Regulations 1996 which complies with the EC Hazardous Waste Directive - Directive 91/689/EEC.

We recommend you dispose of the appropriate materials in accordance with the valid environmental control laws. The following table shows which materials can be recycled and which have to be disposed of in a special way.

Material	Recycle	Disposal
metal	yes	no
plastics material	yes	no
printed circuit board	no	yes

The printed circuit board should be disposed of in one of two ways:

1. High temperature incineration (minimum temperature 1200°C) by an incinerator authorised under parts A or B of the Environmental Protection Act
2. Disposal in an engineered land fill site that is licensed to take aluminium electrolytic capacitors. Do not dispose of in a land fill site set aside for domestic waste.

Packaging

During transport our products are protected by suitable packaging. This is entirely environmentally compatible and should be taken for central disposal as secondary raw material.

Chapter 9

TECHNICAL SPECIFICATIONS

Understanding the Product Code

Model Number (Europe)

The unit is fully identified using a four block alphanumeric code which records how the drive was calibrated, and its various settings when dispatched from the factory.

The Product Code appears as the “Model No.”. Each block of the Product Code is identified as below:

Typical example: **650V-432160C0-002W0-A3** (as shown in the example below)

This is a Frame C 650V, 7.5kW, rated at 400-460 Volts supply, standard livery, wall mounted, with 6521 Keypad fitted displaying UK language, RS232 + RS485 ports fitted, no braking option fitted, no auxiliary supply, no special option.

		Block 1	Block 2	Block 3	Block 4
		650V	43 2160 C 0	0 0 2 W 0	A 3
Family	650V Sensorless vector range	650V			
	Supply Voltage	Heavy Duty kW/A	Standard Duty kW/A	Frame Size	
		HP/A	HP/A		
Rating Data					
	230v 3phase				23
	5.5/22	7.5/22	7.5/28	10/28	C
	7.5/28	10/28	11/42	15/42	C
	11/42	15/42	15/54	20/54	D
	15/54	20/54	18.5/68	25/68	D
	18.5/68	25/68	18.5/68	25/68	D
	22/80	30/80	30/104	40/104	E
	30/104	40/104	37/130	50/130	F
	37/130	50/130	45/154	60/154	F
	45/154	60/154	55/192	75/192	F
	400/460v 3ph				43
	7.5/16	10/14	11/23	15/21	C
	11/23	15/21	15/30	20/27	C
	15/30	20/27	18.5/37	25/34	C
	15/31	20/31	18.5/38	25/38	D
	18.5/38	25/38	22/45	30/45	D
	22/45	30/45	30/59	40/52	D
	30/59	40/52	37/73	50/65	D
	30/59	40/59	37/73	50/73	E
	37/73	50/73	45/87	60/87	E
	45/87	60/87	55/105	75/105	E
	55/105	75/100	75/145	100/125	F
	75/145	100/130	90/165	125/156	F
	90/180	125/156	110/205	150/180	F
	90/180	150/180	110/205	150/180	F
Auxiliary supply	Not required (frames 1-3 & frames C-E)				0
	115v 1ph (Frame F only)				1
	230v 1ph (Frame F only)				2
Brake	Not Fitted (mandatory on F 1 & F 2 230v , optional on Frames D-F)				0
Switch	Fitted (mandatory on F 2 400v & all F 3 & C, optional on Frames D-F)				B
Filter	Not fitted (Optional on frames 1-3, mandatory on frames C-F)				0
	Filter fitted (Optional on frames 1-3 only)				F
Comms	RS232 port fitted				1
	RS232 + RS485 ports fitted (Frames C-F only)				2
Mechanic style	Panel Mount				P
	Wall Mount (option on Frames C-E only)				W
	Through Panel Mount (Option on Frames C-E only)				T
Special Option	None				00
	Documented special options (01-99)				
Destination	English (50Hz)				A
	English (60Hz)				B
	German				D
	Spanish				E
	French				F
	Italian				I
	Swedish				S
Keypad	None				0
	6511 TTL fitted (option on frames 1-3 only)				1
	6511 RS232 fitted (option on frames 1-3 only)				2
	6521 fitted (option on Frames C-F only)				3

Catalog Number (North America)

The unit is identified using a 6 block alphanumeric code which records how the Inverter was calibrated, and its various settings when dispatched from the factory.

The Product Code appears as the “Cat No.”. Each block of the Product Code is identified as below:

Typical example: **650V/0020/460/1BN**

This is a 20Hp 460V, rated at 460 Volts supply, NEMA 1, Braking option fitted, no internal RFI filter.

Frame C, D, E, F – Catalog Number (North America)																																		
Block No.	Variable	Description																																
1	650V	Generic product																																
2	XXXX	Four numbers specifying the power output in Hp: <table border="0" style="width: 100%; border-collapse: collapse;"> <tr> <td style="width: 25%; text-align: center;">Frame C</td> <td style="width: 25%; text-align: center;">Frame D</td> <td style="width: 25%; text-align: center;">Frame E</td> <td style="width: 25%; text-align: center;">Frame F</td> </tr> <tr> <td>0010 = 10Hp</td> <td>0015 = 15Hp</td> <td>0030 = 30Hp</td> <td>0040 = 40Hp</td> </tr> <tr> <td>0015 = 15Hp</td> <td>0020 = 20Hp</td> <td>0040 = 40Hp</td> <td>0050 = 50Hp</td> </tr> <tr> <td>0020C = 20Hp</td> <td>0025 = 25Hp</td> <td>0050 = 50Hp</td> <td>0060 = 60Hp</td> </tr> <tr> <td></td> <td>0030 = 30Hp</td> <td>0060 = 60Hp</td> <td>0075 = 75Hp</td> </tr> <tr> <td></td> <td>0040D = 40Hp</td> <td></td> <td>0100 = 100Hp</td> </tr> <tr> <td></td> <td></td> <td></td> <td>0125 = 125Hp</td> </tr> <tr> <td></td> <td></td> <td></td> <td>0150 = 150Hp</td> </tr> </table>	Frame C	Frame D	Frame E	Frame F	0010 = 10Hp	0015 = 15Hp	0030 = 30Hp	0040 = 40Hp	0015 = 15Hp	0020 = 20Hp	0040 = 40Hp	0050 = 50Hp	0020C = 20Hp	0025 = 25Hp	0050 = 50Hp	0060 = 60Hp		0030 = 30Hp	0060 = 60Hp	0075 = 75Hp		0040D = 40Hp		0100 = 100Hp				0125 = 125Hp				0150 = 150Hp
Frame C	Frame D	Frame E	Frame F																															
0010 = 10Hp	0015 = 15Hp	0030 = 30Hp	0040 = 40Hp																															
0015 = 15Hp	0020 = 20Hp	0040 = 40Hp	0050 = 50Hp																															
0020C = 20Hp	0025 = 25Hp	0050 = 50Hp	0060 = 60Hp																															
	0030 = 30Hp	0060 = 60Hp	0075 = 75Hp																															
	0040D = 40Hp		0100 = 100Hp																															
			0125 = 125Hp																															
			0150 = 150Hp																															
3	XXX	Three numbers specifying the nominal input voltage rating: <table border="0" style="width: 100%; border-collapse: collapse;"> <tr> <td style="width: 33%; text-align: center;">230</td> <td style="width: 33%; text-align: center;">220 to 240V (±10%) 50/60Hz</td> <td style="width: 33%;"></td> </tr> <tr> <td style="text-align: center;">460</td> <td style="text-align: center;">380 to 460V (±10%) 50/60Hz</td> <td></td> </tr> </table>	230	220 to 240V (±10%) 50/60Hz		460	380 to 460V (±10%) 50/60Hz																											
230	220 to 240V (±10%) 50/60Hz																																	
460	380 to 460V (±10%) 50/60Hz																																	
4	X	Enclosure option: 1 - Nema 1 (IP20 and falling dirt protection (UL Type 1) and remote keypad with Comms) C - Open Chassis style (IP20 only) and remote keypad with Comms																																
5	X	Characters specifying the braking option: N Brake power switch not fitted (Frames D & E only) B Brake power switch fitted - no braking resistors supplied Note: External braking resistors should be specified and ordered separately.																																
6	X	Characters specifying the fitting of the internal RFI filter: N No internal RFI filter installed B Internal RFI filter installed																																

9-4 Technical Specifications

Environmental Details		
Operating Temperature HEAVY DUTY NORMAL DUTY	Operating temperature is defined as the ambient temperature to the immediate surround of the drive, when the drive and other equipment adjacent to it is operating at worst case conditions. 0°C to 45°C (0°C to 40°C with top cover fitted), derate up to a maximum of 50°C 0°C to 40°C (0°C to 35°C with top cover fitted), derate up to a maximum of 50°C Output power is derated linearly at 2% per degree centigrade for temperature exceeding the maximum rating ambient for the drive.	
Storage Temperature	-25°C to +55°C	
Shipping Temperature	-25°C to +70 °C	
Product Enclosure Rating	Wall Mounted (top cover must be fitted)	IP40 - top cover surface (Europe) IP20 - remainder of surfaces (Europe) UL (c-UL) Type 1 (North America/Canada)
	Cubicle Mounted (without top cover fitted)	IP20 UL (c-UL) Open Type (North America/Canada)
	Through-panel Mounted (without top cover fitted)	IP20 UL (c-UL) Open Type (North America/Canada)
Altitude	If greater than 1000m above sea level, derate by 1% per 100m to a maximum of 2000m	
Humidity	Maximum 85% relative humidity at 40°C non-condensing	
Atmosphere	Non flammable, non corrosive and dust free	
Climatic Conditions	Class 3k3, as defined by EN50178 (1998)	
Vibration	Test Fc of EN60068-2-6 10Hz <= f <= 57Hz sinusoidal 0.075mm amplitude 57Hz <= f <= 150Hz sinusoidal 1g 10 sweep cycles per axis on each of three mutually perpendicular axis	
Safety	Overvoltage Category Pollution Degree	Overvoltage Category III (numeral defining an impulse withstand level) Pollution Degree II (non-conductive pollution, except for temporary condensation) Pollution Degree III (dirty air rating for through-panel mounted parts)
	Europe	When fitted inside a cubicle, or when wall-mounted and the top cover is firmly screwed in position, this product conforms with the Low Voltage Directive 2006/95/EC.
	North America/Canada	Without the top cover fitted, complies with the requirements of UL508C as an open-type drive. When the top cover is fitted, complies with the requirements of UL508C as Type 1 Enclosed (for direct wall mounting applications) when specified with Model Number Block 6 (Frame B) or Model Number Block 4 (Frame C, D, E, F) designation xx20 or xx21 only.

Earthing/Safety Details	
Earthing	Permanent earthing is mandatory on all units. <ul style="list-style-type: none"> Use a copper protective earth conductor 10mm² minimum cross-section, or install a second conductor in parallel with the protective conductor to a separate protective earth terminal The conductor itself must meet local requirements for a protective earth conductor
Input Supply Details (TN) and (IT)	Drives without filters are suitable for earth (TN) or non-earth referenced (IT) supplies. The drive is only suitable for earth referenced supplies (TN) when fitted with an internal filter. External filters are available for use on TN and IT (non-earth referenced) supplies.
Prospective Short Circuit Current (PSCC)	Refer to the appropriate Electrical Ratings table.
Earth Leakage Current	> 10mA (all models)

Cabling Requirements for EMC Compliance					
	Power Supply Cable	Motor Cable	External AC Supply EMC Filter to Drive Cable	Brake Resistor Cable	Signal/Control Cable
Cable Type (for EMC Compliance)	Unscreened	Screened/armoured	Screened/armoured	Screened/armoured	Screened
Segregation	From all other wiring (clean)	From all other wiring (noisy)			From all other wiring (sensitive)
Length Limitations With External AC Supply EMC Filter	Unlimited	50 metres	0.3 metres	25 metres	25 metres
Screen to Earth Connection		Both ends	Both ends	Both ends	Drive end only
Output Choke		300 metres maximum			
* Maximum motor cable length under any circumstances					

Cooling Fans		
<p>The forced-vent cooling of the drive is achieved by 1, or in some cases 2 fans. The Fan Rating gives the volume of air venting from the drive. All except the Frame F fans are internally-supplied 24V fans.</p>		
Drive Product Code	Drive Catalog Code	Fan Ratings
FRAME C		
650V-23222C..	650V/0055/..	42.5cfm (72 m ³ /hr)
650V-232280C..	650V/0010/..	25cfm (42.5 m ³ /hr)
650V-432230C & 650V-432300C	650V/0015/.. & 650V/0020C/..	35cfm (59.5 m ³ /hr)
FRAME D		
650V-232540D, 650V-232680D & 650V-432450D	650V/0020/.., 650V/0025/.. & 650V/0030/..	55cfm (93.4 m ³ /hr)
650V-432590D	650V/0040/..	81cfm (138 m ³ /hr)
FRAME E		
All models	All models	160cfm (272 m ³ /hr)
FRAME F		
<p>One single phase fan is provided, supplied from an auxiliary input. There are two voltage variants, either 115V ac or 220Vac. The fan is powered from a single phase supply which uses a capacitor to generate the quadrature phase. Protect the fan using a 3A fuse.</p> <p>110/120V : 130W, 10μF, Stator - 16Ω 220/240V : 140W, 2.5μF, Stator - 62Ω</p>		
All models	All models	270cfm (459 m ³ /hr)

9-6 Technical Specifications

Electrical Ratings (230V Build Variant)								
Power Supply = 220-240V ±10%, 45-60Hz								
Motor power, output current and input current must not be exceeded under steady state operating conditions.								
Operation at 208V ±10% (Frames C, D, E & F)								
Nominal motor powers are reduced by 10% when operated at 208V ±10%. Output currents remain unchanged.								
Model Number (Europe)	Catalog Number (North America)	Motor Power	Output Current (A)	Input Current (A)	Heatsink Power Loss (W)	Total Power Loss (W)	Maximum Switching Frequency (kHz)	Input Bridge I ² t (A ² s)
FRAME C : Input currents for kW ratings are at 230V 50Hz ac input. Supply short circuit rating 10kA.								
Heavy Duty (Output Overload Motoring 150% for 30s, 180% for 0.5s short term rating)								
650V-232220C	650V/0007/230/..	5.5kW	22	25	270	330	3	4000
		7.5Hp	22	25	270	330	3	4000
650V-232280C	650V/0010/230/..	5.5kW	28	33	290	350	3	6000
		10Hp	28	33	290	350	3	6000
Normal Duty (Output Overload Motoring 110% for 30s, 130% for 0.5s short term rating)								
650V-232220C	650V/0007/230/..	7.5kW	28	31	330	390	3	4000
		10Hp	28	31	330	390	3	4000
650V-232280C	650V/0010/230/..	11kW	42	49.3	500	560	3	6000
		15Hp	42	49.3	500	560	3	6000
FRAME D : Input currents for kW ratings are at 230V 50Hz ac input. Supply short circuit rating 10kA.								
Heavy Duty (Output Overload Motoring 150% for 30s, 180% for 0.5s short term rating)								
650V-232420D	650V/0015/230/..	11kW	42	45	570	640	3	6000
		15Hp	42	45	570	640	3	6000
650V-232540D	650V/0020/230/..	15kW	54	53	670	740	3	6000
		20Hp	54	53	670	740	3	6000
650V-232680D	650V/0025/230/..	18.5kW	68	65	850	920	3	6000
		25Hp	68	65	850	920	3	6000
Normal Duty (Output Overload Motoring 110% for 30s, 130% for 0.5s short term rating)								
650V-232420D	650V/0015/230/..	15kW	54	54	750	820	3	6000
		20Hp	54	54	750	820	3	6000
650V-232540D	650V/0020/230/..	18.5kW	68	65	850	920	3	6000
		25Hp	68	65	850	920	3	6000
650V-232680D	650V/0025/230/..	All values are the same as for Heavy Duty except for changes described by parameter P12. Refer to Chapter 6 : "Programming Your Application"						
FRAME E : Input currents for kW ratings are at 230V 50Hz ac input. Prospective short circuit current 18kA.								
Heavy Duty (Output Overload Motoring 150% for 30s, 180% for 0.5s short term rating)								
650V-232800E	650V/0030/230/..	22kW	80	91	800	920	3	18000
		30Hp	80	91	800	920	3	18000
Normal Duty (Output Overload Motoring 110% for 30s, 130% for 0.5s short term rating)								
650V-232800E	650V/0030/230/..	30kW	104	116	1050	1200	3	18000
		40Hp	104	116	1050	1200	3	18000

Electrical Ratings (230V Build Variant)

Power Supply = 220-240V ±10%, 45-60Hz

Motor power, output current and input current must not be exceeded under steady state operating conditions.

Operation at 208V ±10% (Frames C, D, E & F)

Nominal motor powers are reduced by 10% when operated at 208V ±10%. Output currents remain unchanged.

Model Number (Europe)	Catalog Number (North America)	Motor Power	Output Current (A)	Input Current (A)	Heatsink Power Loss (W)	Total Power Loss (W)	Maximum Switching Frequency (kHz)	Input Bridge I ² t (A ² s)
FRAME F : Input currents for kW ratings are at 230V 50Hz ac input. Prospective short circuit current 18kA.								
Heavy Duty (Output Overload Motoring 150% for 30s, 180% for 0.5s short term rating)								
650V-233104F	650V/0040/230/..	30kW	104	102	850	1100	3	100000
		40Hp	104	102	850	1100	3	100000
650V-233130F	650V/0050/230/..	37kW	130	126	1100	1450	3	100000
		50Hp	130	126	1100	1450	3	100000
650V-233154F	650V/0060/230/..	45kW	154	148	1200	1650	3	100000
		60Hp	154	148	1200	1650	3	100000
Normal Duty (Output Overload Motoring 110% for 30s, 125% for 0.5s short term rating)								
650V-233104F	650V/0040/230/..	37kW	130	126	1150	1500	3	100000
		50Hp	130	126	1150	1500	3	100000
650V-233130F	650V/0050/230/..	45kW	154	148	1350	1800	3	100000
		60Hp	154	148	1350	1800	3	100000
650V-233154F	650V/0060/230/..	55kW	192	184	1600	2100	3	100000
		75Hp	192	184	1600	2100	3	100000

Electrical Ratings (400V Build Variant)

Power Supply = 380-460V ±10%, 50/60Hz ±5%

Motor power, output current and input current must not be exceeded under steady state operating conditions.

Model Number (Europe)	Catalog Number (North America)	Motor Power	Output Current (A)	Input Current (A)	Heatsink Power Loss (W)	Total Power Loss (W)	Maximum Switching Frequency (kHz)	Input Bridge I ² t (A ² s)
FRAME C : Input currents for kW ratings are at 400V 50Hz ac input, and for Hp ratings at 460V 60Hz ac input. Prospective short circuit current 10kA. * For UL Listed products rated at 15kW/20Hp, a supply voltage of 460V is required. The higher current ratings are applicable to non UL applications only.								
Heavy Duty (Output Overload Motoring 150% for 30s, 180 % for 0.5s short term rating)								
650V-432160C	650V/0010/460/..	7.5kW	16	19	240	290	3	4000
		10Hp	14	16	225	275	3	4000
650V-432230C	650V/0015/460/..	11kW	23	26.1	280	330	3	4000
		15Hp	21	22.1	260	310	3	4000
650V-432300C	650V/0020C/460/..	15kW	30	37	440	500	3	6000
		20Hp	27	31.2	410	470	3	6000

9-8 Technical Specifications

Electrical Ratings (400V Build Variant)

Power Supply = 380-460V \pm 10%, 50/60Hz \pm 5%

Motor power, output current and input current must not be exceeded under steady state operating conditions.

Model Number (Europe)	Catalog Number (North America)	Motor Power	Output Current (A)	Input Current (A)	Heatsink Power Loss (W)	Total Power Loss (W)	Maximum Switching Frequency (kHz)	Input Bridge I ² t (A ² s)
Normal Duty (Output Overload Motoring 110% for 30s)								
650V-432160C	650V/0010/460/..	11kW	23	26.1	300	350	3	4000
		15Hp	21	22.1	280	320	3	4000
650V-432230C	650V/0015/460/..	15kW	30	33.6	440	500	3	4000
		20Hp	27	28.5	410	470	3	4000
650V-432300C	650V/0020C/460/..	18.5kW	37	44	550	610	3	6000
		25Hp	34	38	530	580	3	6000
FRAME D : Input currents for kW ratings are at 400V 50Hz ac input and for Hp ratings at 460V 60Hz ac input. Prospective short circuit current 10kA. * For UL Listed products rated at 30kW/40Hp, a supply voltage of 460V is required. The higher current ratings are applicable to non UL applications only.								
Heavy Duty (Output Overload Motoring 150% for 30s, 180% for 0.5s short term rating)								
650V-432310D	650V/0020/460/..	15kW	31	34.8	420	480	3	4000
		20Hp	31	28.5	400	460	3	4000
650V-432380D	650V/0025/460/..	18.5kW	38	40.5	545	605	3	6000
		25Hp	38	34.2	515	575	3	6000
650V-432450D	650V/0030/460/..	22kW	45	47.2	670	730	3	6000
		30Hp	45	40	640	700	3	6000
650V-432590D	650V/0040D/460/..	30kW	59	66	760	860	3	15000
		40Hp	52	56	740	830	3	15000
Normal Duty (Output Overload Motoring 110% for 30s)								
650V-432310D	650V/0020/460/..	18.5kW	38	40.5	545	605	3	4000
		25Hp	38	34.2	515	575	3	4000
650V-432380D	650V/0025/460/..	22kW	45	47.2	670	730	3	6000
		30Hp	45	40	640	700	3	6000
650V-432450D	650V/0030/460/..	30kW	59	61	760	860	3	6000
		40Hp	52	51	740	830	3	6000
650V-432590D	650V/0040D/460/..	37kW	73	84	920	1030	3	15000
		50Hp	65	68	890	980	3	15000

Electrical Ratings (400V Build Variant)

Power Supply = 380-460V ±10%, 50/60Hz ±5%

Motor power, output current and input current must not be exceeded under steady state operating conditions.

Model Number (Europe)	Catalog Number (North America)	Motor Power	Output Current (A)	Input Current (A)	Heatsink Power Loss (W)	Total Power Loss (W)	Maximum Switching Frequency (kHz)	Input Bridge I ² t (A ² s)
FRAME E : Input currents for kW ratings are at 400V 50Hz ac input and for Hp ratings at 460V 60Hz ac input. Prospective short circuit current 18kA. * For UL Listed products rated at 30kW/40Hp, a supply voltage of 460V is required. The higher current ratings are applicable to non UL applications only.								
Heavy Duty (Output Overload Motoring 150% for 30s, 180% for 0.5s short term rating)								
650V-432590E	650V/0040/460/..	30kW	59	68	590	690	3	15000
		40Hp	59	57	590	690	3	15000
650V-432730E	650V/0050/460/..	37kW	73	81	730	850	3	18000
		50Hp	73	68	730	850	3	18000
650V-432780E	650V/0060/460/..	45kW	87	95	880	880	3	18000
		60Hp	87	80	880	880	3	18000
Normal Duty (Output Overload Motoring 110% for 30s)								
650V-432590E	650V/0040/460/..	37kW	73	81	733	848	3	15000
		50Hp	73	68	733	848	3	15000
650V-432730E	650V/0050/460/..	45kW	87	95	901	1029	3	18000
		60Hp	87	80	901	1029	3	18000
650V-432780E	650V/0060/460/..	55kW	105	110	1094	1242	3	18000
		75Hp	105	95	1094	1242	3	18000
FRAME F : Input currents for kW ratings are at 400V 50Hz ac input and for Hp ratings at 460V 60Hz ac input. Prospective short circuit current 18kA.								
Heavy Duty (Output Overload Motoring 150% for 30s, 180% for 0.5s short term rating)								
650V-433105F	650V/0075/460/..	55kW	105	114	920	1220	3	100,000
		75Hp	100	99	900	1130	3	100,000
650V-433145F	650V/0100/460/..	75kW	145	143	1320	1670	3	100,000
		100Hp	130	124	1200	1500	3	100,000
650V-433156F	650V/0125/460/..	90kW	180	164	1490	1950	3	100,000
		125Hp	156	148	1340	1780	3	100,000
650V-433180F	650V/0150/460/..	90kW	180	164	1490	1950	3	100,000
		150Hp	180	169	1670	2180	3	100,000
Normal Duty (Output Overload Motoring 110% for 30s)								
650V-433105F	650V/0075/460/..	75kW	145	143	1400	1670	3	100,000
		100Hp	125	124	1200	1500	3	100,000
650V-433145F	650V/0100/460/..	90kW	165	164	1580	1950	3	100,000
		125Hp	156	148	1340	1780	3	100,000
650V-433156F	650V/0125/460/..	110kW	205	195	1800	1950	3	100,000
		150Hp	180	169	1670	2180	3	100,000
650V-433180F	650V/0150/460/..	110kW	205	195	1800	1950	3	100,000
		150Hp	180	169	1670	2180	3	100,000

9-10 Technical Specifications

Input Fuse Ratings (Europe)

Refer to Chapter 10 for North American fuse ratings.

Product Code	Input Fuse Rating (A)		Product Code	Input Fuse Rating (A)	
Model Number	HEAVY DUTY	NORMAL DUTY	Model Number	HEAVY DUTY	NORMAL DUTY
230V BUILD VARIANT 220-240V \pm 10%, 45-65Hz *					
Frame C			Frame E		
650V-232220C	25	32	650V-232800E	100	125
650V-232280C	40	50			
Frame D			Frame F		
650V-232420D	50	63	650V-233104F	125	160
650V-232540D	63	80	650V-233130F	160	160
650V-232680D	80	-	650V-233154F	160	200
400V BUILD VARIANT 380-460V \pm 10%, 45-65Hz *					
Frame C			Frame E		
650V-432160C	20	32	650V-432590E	80	100
650V-432230C	32	40	650V-432730E	100	100
650V-432300C	40	50	650V-432870E	100	125
Frame D			Frame F		
650V-432310D	40	50	650V-433105F	125	160
650V-432380C	50	50	650V-433145F	160	200
650V-432450D	50	63	650V-433156F	200	200
650V-432590D	80	100	650V-433180F	200	200

External AC Supply (RFI) Filters									
Drive	Filter Part No.	Motor Power (kW/HP)	Phase	Watt Loss (W)	Fault Leakage Current (mA)	Current (A)	Maximum Supply Voltage (V)	EMC Performance Class	Maximum Motor Cable Length (m)
Frame C	CO467842U044 : 500V (IT/TN Filter)	7.5-18.5/10-25 normal duty	3	14	80	35	500	B	50
	CO467842U084 : 500V (IT/TN Filter)	18.5-37/25-50 normal duty	3	18	86	64	500	B	50
Frame D	CO467842U105 : 500V (IT/TN Filter)	37-55/50-75 normal duty	3	50	200	124	500	B	50
Frame E	CO467842U215 : 500V (IT/TN Filter)	75-110/100-150 normal duty	3	60	450	205	500	B	50
Frame F	CO467842U215 : 500V (IT/TN Filter)	75-110/100-150 normal duty	3	60	450	205	500	B	50
Filters suitable for 50-60Hz \pm 5%, switching frequency 3 & 6kHz									

EMC Compliance					
Standard EN 61800-3		Frame C	Frame D	Frame E	Frame F
Conducted emissions Table 14	Unrestricted Distribution Category C1	When fitted with the specified external filter	When fitted with the specified external filter	When fitted with the specified external filter	When fitted with the specified external filter
Conducted emissions Table 14	Category C2 Restricted Distribution	When fitted with the specified external filter	When fitted with the specified external filter	When fitted with the specified external filter	When fitted with the specified external filter
Radiated Emissions Table 15	Category C1 Unrestricted Distribution	No	No	No	No
Radiated Emissions Table 15	Category C2 Restricted Distribution	Yes	Yes	Yes	Yes
Conducted emissions Table 17	Category C3 Where $I \leq 100A$	Yes	Yes	Yes	Yes
Conducted emissions Table 17	Category C3 Where $I > 100A$	N/A	N/A	N/A	Yes
Radiated Emissions Table 18	Category C3 Second environment	Yes	Yes	Yes	Yes

9-12 Technical Specifications

Internal Dynamic Brake Switch (Frame C)						
Model Number (Europe)	Motor Power (kW/hp)	Brake Switch Peak Current (A)	Peak Brake Dissipation (kW/hp)	Brake Switch Continuous Current (A)	Continuous Brake Dissipation (kW/hp)	Minimum Brake Resistor Value (Ω)
		20s maximum, 30% duty				
230V Build Variant: 220-240V \pm10% DC link brake voltage: 390V						
650V-232220C	5.5/7.5	13.5	5.2/6.9	4.0	1.6/2.1	29
650V-232280C	7.5/10	17.7	6.9/9.2	5.3	2.1/2.8	22
400V Build Variant: 380-460V \pm10%, 45-65Hz DC link brake voltage: 750V						
650V-432160C	7.5/10	15	11/15	4.5	3.4/4.5	50
650V-432230C	11/15	15	11/15	4.5	3.4/4.5	50
650V-432300C	15/20	15	11/15	4.5	3.4/4.5	50

Internal Dynamic Brake Switch (Frame D)						
Model Number (Europe)	Motor Power (kW/hp)	Brake Switch Peak Current (A)	Peak Brake Dissipation (kW/hp)	Brake Switch Continuous Current (A)	Continuous Brake Dissipation (kW/hp)	Minimum Brake Resistor Value (Ω)
		20s maximum, 30% duty				
230V Build Variant: 220-240V \pm10% DC link brake voltage: 390V						
650V-232420D	11/15	28	10.9/14.5	8.4	3.3/4.4	14
650V-232540D	15/20	39	15.2/20.3	11.7	4.6/6.1	10
650V-232680D	18.5/25	49	19.0/25.3	14.7	5.7/7.6	8
400V Build Variant: 380-460V \pm10%, 45-65Hz DC link brake voltage: 750V						
650V-432310D	15/20	30	22/30	9.5	7/10	27
650V-432380D	18.5/25	30	22/30	9.5	7/10	27
650V-432450D	22/30	30	22/30	9.5	7/10	27
650V-432590D	30/37	37	30/40	12.5	9/12	21

Internal Dynamic Brake Switch (Frame E)						
Model Number (Europe)	Motor Power (kW/hp)	Brake Switch Peak Current (A)	Peak Brake Dissipation (kW/hp)	Brake Switch Continuous Current (A)	Continuous Brake Dissipation (kW/hp)	Minimum Brake Resistor Value (Ω)
		20s maximum, 30% duty				
230V Build Variant: 220-240V \pm10% DC link brake voltage: 390V						
650V-232800E	22/30	56	21.7/28.9	16.8	6.5/8.7	7
400V Build Variant: 380-460V \pm10%, 45-65Hz DC link brake voltage: 750V						
650V-432590E	30/40	40	30/40	12	9/12	19
650V-432730E	37/50	50	37/50	15	10.5/14	15
650V-432870E	45/60	60	45/60	18	13.5/18	12

Internal Dynamic Brake Switch (Frame F)						
Model Number (Europe)	Motor Power (kW/hp)	Brake Switch Peak Current (A)	Peak Brake Dissipation (kW/hp)	Brake Switch Continuous Current (A)	Continuous Brake Dissipation (kW/hp)	Minimum Brake Resistor Value (Ω)
230V Build Variant: 220-240V \pm10% DC link brake voltage: 390V						
650V-233104F	30/40	78	30/41	23.4	23/12	5
650V-233130F	37/50	98	38/51	29.4	11/15	4
650V-233154F	45/60	130	51/68	39.0	15/20	3
400V Build Variant: 380-460V \pm10%, 45-65Hz DC link brake voltage: 750V						
20s maximum, 25% duty						
650V-433105F	55/75	94	62/83	25	18/25	8
650V-433145F	75/100	125	90/125	32	24/32	6
650V-433156F	90/125	136	102/137	32	24/32	5.5
650V-433180F	90/150	136	102/137	32	24/32	5.5

Supply Short Circuit Rating

Products may be used on 50kA supplies provided an additional supply inductor is fitted, see tables below for further information:

230V

Frame Size	Motor Power	SSD Drives Part Number	MTE Part Number	Inductance mH	Rated amps
C	5.5kW 7.5Hp	CO353013	RL-02501	0.50	25
C	7.5kW 10Hp	CO353014	RL-03501	0.40	35
D	11kW 15Hp	CO353015	RL-04501	0.30	45
D	15kW 20Hp	CO353016	RL-05501	0.25	55
D	18.5kW 25Hp	CO535017	RL-08001	0.20	80
E	22kW 30Hp	CO353017	RL-08001	0.20	80
F	30kW 40Hp	CO470654	RL-10001	0.15	100
F	37kW 50Hp	CO353018	RL-13001	0.10	130
F	45kW 60Hp	CO471264	RL-16001	0.075	160

460V

Frame Size	Motor Power	SSD Drives Part Number	MTE Part Number	Inductance mH	Rated amps
C	7.5kW 10Hp	CO352785	RL-01802	1.50	18
C	11kW 15Hp	CO352786	RL-02502	1.20	25
C	15kW 20Hp	CO352901	RL-03502	0.80	35
D	18.5kW 25Hp	CO352901	RL-03502	0.80	35
D	22kW 30Hp	CO352902	RL-04502	0.70	45
D	30kW 40Hp	CO352903	RL-05502	0.50	55
E	37kW 50Hp	CO352904	RL-08002	0.40	80
E	45kW 60Hp	CO352904	RL-08002	0.40	80
F	55kW 75Hp	CO352905	RL-10002	0.30	100
F	75kW 100Hp	CO352906	RL-13002	0.20	130
F	90kW 125Hp	CO470057	RL-16002	0.15	160
F	90kW 150Hp	CO470045	RL-20002	0.11	200

9-14 Technical Specifications

Analog Inputs/Outputs		
	Inputs	Output
Range	0-10V and 0-5V (no sign) set via parameter ⁵ IP13 (AIN1) 0-10V, 0-5V, 0-20mA or 4-20mA (no sign) set via parameter ⁵ IP23 (AIN2) Absolute maximum input current 25mA in current mode Absolute maximum input voltage 24V dc in voltage mode	0-10V (no sign) Maximum rated output current 10mA, with short circuit protection
Impedance	Voltage range = 31.8k Ω Current range = 200 Ω	Voltage range = 100 Ω
Resolution	10 bits (1 in 1024)	10 bits (1 in 1024)
Dynamic Response	5ms	Bandwidth 15Hz

Digital Inputs																		
Operating Range	DIN1, DIN2, DIN3, DIN4, DIN5: 0-5V dc = OFF, 15-24V dc = ON (absolute maximum input voltage \pm 30V dc) IEC1131 DIN6, DIN7: 0-1.5V dc = OFF, 4-24V dc = ON (absolute maximum input voltage \pm 30V dc) IEC1131	<table border="0"> <tr><td>24V</td><td>ON</td></tr> <tr><td>15V</td><td>undefined state</td></tr> <tr><td>5V</td><td>OFF</td></tr> <tr><td>0V</td><td></td></tr> <tr><td>24V</td><td>ON</td></tr> <tr><td>4V</td><td>undefined state</td></tr> <tr><td>1.5V</td><td>OFF</td></tr> <tr><td>0V</td><td></td></tr> </table>	24V	ON	15V	undefined state	5V	OFF	0V		24V	ON	4V	undefined state	1.5V	OFF	0V	
24V	ON																	
15V	undefined state																	
5V	OFF																	
0V																		
24V	ON																	
4V	undefined state																	
1.5V	OFF																	
0V																		
Input Impedance	6.8k Ω																	
Sample Interval	5ms																	

Relay	
RL1A, RL1B : These are volt-free relay contacts. 50V dc max, 0.3A max (for inductive loads up to L/R=40ms, a suitable freewheel diode must be used).	
Maximum Voltage	250V ac
Maximum Current	4A resistive load

Digital Outputs	
DOUT1 and DOUT2 (DOUT1 is only configurable using DES Lite or other suitable programming tool).	
Nominal Open Circuit Output Voltage	23V (minimum 19V)
Nominal Output Impedance	33 Ω
Rated Output Current	150mA : The total current available is 150mA, either individually or as the sum of terminal 6 & 10.

Supply Harmonic Analysis (Frame C Normal Duty)

Assumptions: 10000A short circuit supply capability, equivalent to 73µH supply impedance at 400V where Q_{In} is the rated rms value of the fundamental voltage of the supply transformer. The results conform to stage 1, stage 2 and stage 3 of the Engineering Recommendation G.5/3 September 1976, Classification 'C': Limits for Harmonics in the UK Electricity Industry.

$$THD(V) \times 100 = \frac{\sqrt{\sum_{h=2}^{h=40} Q_{h^2}}}{Q_{In}} \%$$

Fundamental Voltage (V)	230		400				500			
Inverter Type	Three Phase									
Motor Power (kW)	5.5	7.5	5.5	7.5	11.0	15.0	5.5	7.5	11.0	15.0
Typical Motor Efficiency %	90		90	90	90	90	90	90	90	90
Harmonic No.	RMS Current (A)									
1	23.7		13.3	18.2	25.1	30.7	14.2	16.2	23.1	24.3
3	0.0		0.0	0.0	0.0	0.0	0.0	0.1	0.0	0.1
5	15.9		10.1	14.0	18.6	23.9	10.8	12.7	17.5	19.4
7	10.4		7.5	10.6	13.5	18.4	8.2	9.9	13.0	15.3
9	0.0		0.0	0.0	0.0	0.0	0.0	0.0	0.0	0.0
11	2.1		2.7	4.0	4.3	7.3	3.0	4.2	4.6	6.8
13	1.6		1.2	1.8	1.8	3.4	1.4	2.1	2.0	3.6
15	0.0		0.0	0.0	0.0	0.0	0.0	0.0	0.0	0.0
17	1.1		0.8	1.2	1.5	1.8	0.9	1.1	1.5	1.5
19	0.7		0.7	1.0	1.2	1.8	0.8	1.1	1.3	1.6
21	0.0		0.0	0.0	0.0	0.0	0.0	0.0	0.0	0.0
23	0.6		0.3	0.5	0.6	0.8	0.4	0.5	0.6	0.9
25	0.5		0.3	0.5	0.6	0.7	0.4	0.4	0.6	0.7
27	0.0		0.0	0.0	0.0	0.0	0.0	0.0	0.0	0.0
29	0.3		0.2	0.4	0.4	0.7	0.3	0.4	0.4	0.6
31	0.3		0.2	0.3	0.3	0.5	0.2	0.3	0.3	0.5
33	0.0		0.0	0.0	0.0	0.0	0.0	0.0	0.0	0.0
35	0.2		0.2	0.2	0.3	0.4	0.2	0.2	0.3	0.3
37	0.3		0.1	0.2	0.2	0.4	0.2	0.2	0.2	0.3
39	0.0		0.0	0.0	0.0	0.0	0.0	0.0	0.0	0.0
40	0.0		0.0	0.0	0.0	0.0	0.0	0.0	0.0	0.0
41	0.1		0.1	0.1	0.2	0.2	0.1	0.2	0.2	0.3
42	0.0		0.0	0.0	0.0	0.0	0.0	0.0	0.0	0.0
43	0.2		0.1	0.1	0.2	0.2	0.1	0.1	0.2	0.2
44	0.0		0.0	0.0	0.0	0.0	0.0	0.0	0.0	0.0
45	0.0		0.0	0.0	0.0	0.0	0.0	0.0	0.0	0.0
46	0.0		0.0	0.0	0.0	0.0	0.0	0.0	0.0	0.0
47	0.1		0.1	0.1	0.1	0.2	0.1	0.1	0.1	0.2
48	0.0		0.0	0.0	0.0	0.0	0.0	0.0	0.0	0.0
49	0.2		0.1	0.1	0.1	0.2	0.1	0.1	0.1	0.2
50	0.0		0.0	0.0	0.0	0.0	0.0	0.0	0.0	0.0
Total RMS Current (A)	30.6		18.6	25.7	34.4	43.9	19.9	23.4	32.2	35.6
THD (V) %	0.68		0.4848	0.6858	0.8634	1.1883	0.5286	0.6545	0.8396	1.0236

9-16 Technical Specifications

Supply Harmonic Analysis (Frame C Heavy Duty)

Assumptions: 10000A short circuit supply capability, equivalent to 73μH supply impedance at 400V where Q_{in} is the rated rms value of the fundamental voltage of the supply transformer. The results conform to stage 1, stage 2 and stage 3 of the Engineering Recommendation G.5/3 September 1976, Classification 'C': Limits for Harmonics in the UK Electricity Industry.

$$THD(V) \times 100 = \sqrt{\frac{\sum_{h=2}^{h=40} Q_{h^2}}{Q_{1n}}} \%$$

Fundamental Voltage (V)	230		400				500			
Inverter Type	Three Phase									
Motor Power (kW)	5.5	7.5	5.5	7.5	11.0	15.0	5.5	7.5	11.0	15.0
Typical Motor Efficiency %	90	90	90	90	90	90	90	90	90	90
Harmonic No.	RMS Current (A)									
1	18.5	23.8	10.1	13.0	18.6	25.1	9.7	17.8	18.6	19.5
3	0.0	0.0	0.0	0.0	0.0	0.0	0.0	0.0	0.0	0.0
5	13.0	18.0	7.9	10.3	14.2	19.9	7.7	13.9	14.4	15.9
7	8.9	13.3	6.1	8.1	10.8	15.6	6.0	10.7	11.0	12.8
9	0.0	0.0	0.0	0.0	0.0	0.0	0.0	0.0	0.0	0.0
11	2.2	4.6	2.4	3.6	4.0	6.8	2.6	4.3	4.3	6.2
13	1.2	2.0	1.2	1.9	1.8	3.5	1.4	2.1	2.1	3.5
15	0.0	0.0	0.0	0.0	0.0	0.0	0.0	0.0	0.0	0.0
17	1.0	1.5	0.6	0.8	1.2	1.5	0.6	1.2	1.2	1.2
19	0.6	1.3	0.6	0.9	1.1	1.5	0.6	1.1	1.1	1.3
21	0.0	0.0	0.0	0.0	0.0	0.0	0.0	0.0	0.0	0.0
23	0.5	0.6	0.3	0.5	0.5	0.9	0.3	0.6	0.6	0.9
25	0.4	0.6	0.3	0.3	0.5	0.6	0.3	0.5	0.5	0.6
27	0.0	0.0	0.0	0.0	0.0	0.0	0.0	0.0	0.0	0.0
29	0.3	0.4	0.2	0.3	0.4	0.6	0.2	0.4	0.4	0.5
31	0.3	0.3	0.2	0.3	0.3	0.5	0.2	0.3	0.3	0.5
33	0.0	0.0	0.0	0.0	0.0	0.0	0.0	0.0	0.0	0.0
35	0.2	0.3	0.1	0.2	0.2	0.3	0.1	0.2	0.3	0.3
37	0.2	0.3	0.1	0.2	0.2	0.3	0.1	0.2	0.2	0.3
39	0.0	0.0	0.0	0.0	0.0	0.0	0.0	0.0	0.0	0.0
40	0.0	0.0	0.0	0.0	0.0	0.0	0.0	0.0	0.0	0.0
41	0.1	0.2	0.1	0.1	0.2	0.2	0.1	0.2	0.2	0.2
42	0.0	0.0	0.0	0.0	0.0	0.0	0.0	0.0	0.0	0.0
43	0.1	0.2	0.1	0.1	0.1	0.2	0.1	0.1	0.2	0.2
44	0.0	0.0	0.0	0.0	0.0	0.0	0.0	0.0	0.0	0.0
45	0.0	0.0	0.0	0.0	0.0	0.0	0.0	0.0	0.0	0.0
46	0.0	0.0	0.0	0.0	0.0	0.0	0.0	0.0	0.0	0.0
47	0.1	0.1	0.1	0.1	0.1	0.2	0.1	0.1	0.1	0.2
48	0.0	0.0	0.0	0.0	0.0	0.0	0.0	0.0	0.0	0.0
49	0.1	0.1	0.1	0.1	0.1	0.2	0.1	0.1	0.1	0.2
50	0.0	0.0	0.0	0.0	0.0	0.0	0.0	0.0	0.0	0.0
Total RMS Current (A)	24.5	33.2	14.5	18.9	26.2	36.5	14.2	25.5	26.5	29.2
THD (V) %	0.57	0.86	0.40	0.54	0.70	1.03	0.40	0.70	0.72	0.87

Supply Harmonic Analysis (Frame D Normal Duty)

Assumptions: 10000A short circuit supply capability, equivalent to 73μH supply impedance at 400V where Q_{in} is the rated rms value of the fundamental voltage of the supply transformer. The results conform to stage 1, stage 2 and stage 3 of the Engineering Recommendation G.5/3 September 1976, Classification 'C': Limits for Harmonics in the UK Electricity Industry.

$$THD(V) \times 100 = \frac{\sqrt{\sum_{h=2}^{h=40} Q_{h^2}}}{Q_{1n}} \%$$

Fundamental Voltage (V)	230			400				500				
Inverter Type	Three Phase											
Motor Power (kW)	11.0	15.0	18.0	15.0	18.0	22.0	30.0	15.0	18.0	22.0	30.0	
Typical Motor Efficiency %	90	90		90	90	90	90	90	90	90	90	
Harmonic No.	RMS Current (A)											
1	47.2	59.2		30.6	36.3	48.2	67.7	23.4	29.0	38.6	*	
3	0.0	0.0		0.0	0.0	0.0	0.0	0.0	0.1	0.0		
5	22.5	23.3		21.6	24.8	31.0	41.7	17.6	20.9	26.6		
7	12.5	11.5		14.7	16.4	19.6	25.5	13.0	14.7	17.8		
9	0.0	0.0		0.0	0.0	0.0	0.0	0.0	0.0	0.0		
11	3.3	4.4		3.7	3.6	3.4	4.0	4.5	4.2	4.1		
13	2.7	3.0		2.0	2.4	3.3	4.7	2.1	2.1	2.6		
15	0.0	0.0		0.0	0.0	0.0	0.0	0.0	0.0	0.0		
17	1.8	2.5		1.7	1.8	1.8	2.1	1.6	1.8	2.0		
19	1.3	1.7		1.1	1.1	1.4	1.9	1.3	1.3	1.2		
21	0.0	0.0		0.0	0.0	0.0	0.0	0.0	0.0	0.0		
23	1.2	1.6		0.9	1.0	1.0	1.3	0.6	0.8	1.1		
25	0.9	1.2		0.7	0.8	0.8	1.1	0.6	0.8	0.8		
27	0.0	0.0		0.0	0.0	0.0	0.0	0.0	0.0	0.0		
29	0.8	1.1		0.5	0.6	0.6	0.9	0.4	0.4	0.6		
31	0.7	0.9		0.5	0.5	0.6	0.7	0.4	0.4	0.5		
33	0.0	0.0		0.0	0.0	0.0	0.0	0.0	0.0	0.0		
35	0.6	0.8		0.3	0.3	0.4	0.6	0.3	0.3	0.4		
37	0.5	0.7		0.3	0.3	0.5	0.5	0.3	0.3	0.4		
39	0.0	0.0		0.0	0.0	0.0	0.0	0.0	0.0	0.0		
40	0.0	0.0		0.0	0.0	0.0	0.0	0.0	0.0	0.0		
41	0.4	0.6		0.2	0.2	0.2	0.5	0.2	0.2	0.3		
42	0.0	0.0		0.0	0.0	0.0	0.0	0.0	0.0	0.0		
43	0.4	0.5		0.2	0.2	0.4	0.4	0.2	0.2	0.2		
44	0.0	0.0		0.0	0.0	0.0	0.0	0.0	0.0	0.0		
45	0.0	0.0		0.0	0.0	0.0	0.0	0.0	0.0	0.0		
46	0.0	0.0		0.0	0.0	0.0	0.0	0.0	0.0	0.0		
47	0.3	0.4		0.2	0.2	0.2	0.3	0.1	0.2	0.2		
48	0.0	0.0		0.0	0.0	0.0	0.0	0.0	0.0	0.0		
49	0.3	0.4		0.2	0.2	0.3	0.3	0.1	0.2	0.2		
50	0.0	0.0		0.0	0.0	0.0	0.0	0.0	0.0	0.0		
Total RMS Current (A)	54.0	65.0		40.5	47.2	60.8	83.8	32.6	39.1	50.5		
THD (V) %	0.97	1.05		0.96	1.08	1.30	1.72	0.85	0.96	1.16		

* Please contact Parker SSD Drives

9-18 Technical Specifications

Supply Harmonic Analysis (Frame D Heavy Duty)

Assumptions: 10000A short circuit supply capability, equivalent to 73µH supply impedance at 400V where Q_{In} is the rated rms value of the fundamental voltage of the supply transformer. The results conform to stage 1, stage 2 and stage 3 of the Engineering Recommendation G.5/3 September 1976, Classification 'C': Limits for Harmonics in the UK Electricity Industry.

$$THD(V) \times 100 = \frac{\sqrt{\sum_{h=2}^{h=40} Q_{h^2}}}{Q_{In}} \%$$

Fundamental Voltage (V)	230			400				500			
Inverter Type	Three Phase										
Motor Power (kW)	11.0	15.0	18.0	15.0	18.0	22.0	30.0	15.0	18.0	22.0	30.0
Typical Motor Efficiency %	90	90	90	90	90	90	90	90	90	90	90
Harmonic No.	RMS Current (A)										
1	37.4	46.7	59.2	25.8	30.6	36.3	51.5	19.4	24.2	29.0	*
3	0.0	0.0	0.0	0.0	0.0	0.0	0.0	0.0	0.0	0.1	
5	20.8	21.1	23.3	18.6	21.6	24.8	34.2	14.9	17.9	20.9	
7	12.7	11.5	11.5	13.1	14.7	16.4	21.8	11.3	13.0	14.7	
9	0.0	0.0	0.0	0.0	0.0	0.0	0.0	0.0	0.0	0.0	
11	2.5	3.4	4.4	3.7	3.7	3.6	4.2	4.3	4.2	4.2	
13	2.5	2.6	3.0	1.8	2.0	2.4	3.4	2.1	2.0	2.1	
15	0.0	0.0	0.0	0.0	0.0	0.0	0.0	0.0	0.0	0.0	
17	1.4	1.9	2.5	1.6	1.7	1.8	2.2	1.4	1.7	1.8	
19	1.2	1.4	1.7	1.1	1.1	1.1	1.4	1.2	1.2	1.3	
21	0.0	0.0	0.0	0.0	0.0	0.0	0.0	0.0	0.0	0.0	
23	0.9	1.2	1.6	0.7	0.9	1.0	1.3	0.6	0.7	0.8	
25	0.7	0.9	1.2	0.7	0.7	0.8	0.9	0.5	0.7	0.8	
27	0.0	0.0	0.0	0.0	0.0	0.0	0.0	0.0	0.0	0.0	
29	0.7	0.9	1.1	0.4	0.5	0.6	0.7	0.4	0.4	0.4	
31	0.5	0.7	0.9	0.4	0.5	0.5	0.6	0.3	0.4	0.4	
33	0.0	0.0	0.0	0.0	0.0	0.0	0.0	0.0	0.0	0.0	
35	0.5	0.6	0.8	0.3	0.3	0.3	0.5	0.3	0.3	0.3	
37	0.4	0.5	0.7	0.2	0.3	0.3	0.5	0.3	0.3	0.3	
39	0.0	0.0	0.0	0.0	0.0	0.0	0.0	0.0	0.0	0.0	
40	0.0	0.0	0.0	0.0	0.0	0.0	0.0	0.0	0.0	0.0	
41	0.4	0.5	0.6	0.2	0.2	0.2	0.3	0.2	0.2	0.2	
42	0.0	0.0	0.0	0.0	0.0	0.0	0.0	0.0	0.0	0.0	
43	0.3	0.4	0.5	0.2	0.2	0.2	0.3	0.2	0.2	0.2	
44	0.0	0.0	0.0	0.0	0.0	0.0	0.0	0.0	0.0	0.0	
45	0.0	0.0	0.0	0.0	0.0	0.0	0.0	0.0	0.0	0.0	
46	0.0	0.0	0.0	0.0	0.0	0.0	0.0	0.0	0.0	0.0	
47	0.3	0.4	0.4	0.2	0.2	0.2	0.2	0.1	0.1	0.2	
48	0.0	0.0	0.0	0.0	0.0	0.0	0.0	0.0	0.0	0.0	
49	0.2	0.3	0.4	0.1	0.2	0.2	0.3	0.1	0.1	0.2	
50	0.0	0.0	0.0	0.0	0.0	0.0	0.0	0.0	0.0	0.0	
Total RMS Current (A)	44.9	52.8	65.0	34.8	40.5	47.2	65.8	27.5	33.2	39.1	
THD (V) %	0.90	0.93	1.05	0.85	0.96	1.08	1.44	0.74	0.85	0.96	

* Please contact Parker SSD Drives

Supply Harmonic Analysis (Frame E Normal Duty)

Assumptions: 10000A short circuit supply capability, equivalent to 73µH supply impedance at 400V where Q_{1n} is the rated rms value of the fundamental voltage of the supply transformer. The results conform to stage 1, stage 2 and stage 3 of the Engineering Recommendation G.5/3 September 1976, Classification 'C': Limits for Harmonics in the UK Electricity Industry.

$$THD(V) \times 100 = \sqrt{\frac{\sum_{h=2}^{h=40} Q_h^2}{Q_{1n}}} \%$$

Fundamental Voltage (V)	230	400			500		
Inverter Type	Three Phase						
Motor Power (kW)	22.0	30.0	37.0	45.0	30.0	37.0	45.0
Typical Motor Efficiency %	90	90	90	90	90	90	90
Harmonic No.	RMS Current (A)						
1	102.1	64.3	74.8	89.1	51.5	63.6	75.5
3	0.1	0.1	0.1	0.1	0.1	0.0	0.0
5	49.1	41.9	48.7	55.2	35.4	43.1	48.9
7	21.7	26.0	30.3	32.2	23.3	28.0	30.1
9	0.0	0.0	0.0	0.0	0.0	0.0	0.0
11	6.3	4.4	5.0	5.1	5.1	5.7	5.4
13	4.1	4.0	4.6	5.9	3.3	4.1	5.1
15	0.0	0.0	0.0	0.0	0.0	0.0	0.0
17	2.8	2.3	2.7	2.5	2.6	3.0	2.8
19	1.7	1.6	1.8	2.3	1.5	1.8	2.0
21	0.0	0.0	0.0	0.0	0.0	0.0	0.0
23	1.6	1.4	1.6	1.5	1.4	1.6	1.6
25	1.0	0.9	1.1	1.2	1.0	1.2	1.1
27	0.0	0.0	0.0	0.0	0.0	0.0	0.0
29	1.0	0.8	1.0	1.0	0.7	0.9	1.0
31	0.7	0.6	0.7	0.8	0.7	0.8	0.7
33	0.0	0.0	0.0	0.0	0.0	0.0	0.0
35	0.7	0.5	0.6	0.7	0.4	0.6	0.6
37	0.5	0.5	0.5	0.6	0.4	0.6	0.5
39	0.0	0.0	0.0	0.0	0.0	0.0	0.0
40	0.0	0.0	0.0	0.0	0.0	0.0	0.0
41	0.5	0.4	0.4	0.5	0.3	0.4	0.4
42	0.0	0.0	0.0	0.0	0.0	0.0	0.0
43	0.4	0.3	0.4	0.4	0.3	0.4	0.4
44	0.0	0.0	0.0	0.0	0.0	0.0	0.0
45	0.0	0.0	0.0	0.0	0.0	0.0	0.0
46	0.0	0.0	0.0	0.0	0.0	0.0	0.0
47	0.3	0.2	0.3	0.3	0.2	0.3	0.3
48	0.0	0.0	0.0	0.0	0.0	0.0	0.0
49	0.3	0.2	0.3	0.4	0.2	0.3	0.3
50	0.0	0.0	0.0	0.0	0.0	0.0	0.0
Total RMS Current (A)	115.6	81.3	94.6	110.0	67.1	82.2	95.2
THD (V) %	1.84	2.98	3.46	3.84	1.52	1.84	1.02

9-20 Technical Specifications

Supply Harmonic Analysis (Frame E Heavy Duty)

Assumptions: 10000A short circuit supply capability, equivalent to 73μH supply impedance at 400V where Q_{1n} is the rated rms value of the fundamental voltage of the supply transformer. The results conform to stage 1, stage 2 and stage 3 of the Engineering Recommendation G.5/3 September 1976, Classification 'C': Limits for Harmonics in the UK Electricity Industry.

$$THD(V) \times 100 = \frac{\sqrt{\sum_{h=2}^{h=40} Q_{h^2}}}{Q_{1n}} \%$$

Fundamental Voltage (V)	230	400				500		
Inverter Type	Three Phase							
Motor Power (kW)	22.0	30.0	37.0	45.0	30.0	37.0	45.0	
Typical Motor Efficiency %	90	90	90	90	90	90	90	
Harmonic No.	RMS Current (A)							
1	76.7	52.3	62.8	75.5	41.1	52.4	64.4	
3	0.0	0.0	0.0	0.0	0.1	0.1	0.0	
5	42.4	35.3	42.2	48.4	29.3	36.7	43.1	
7	22.2	22.9	27.2	29.4	20.2	24.8	27.6	
9	0.0	0.0	0.0	0.0	0.0	0.0	0.0	
11	4.4	4.5	5.2	4.9	5.3	5.9	5.5	
13	4.3	3.2	3.8	4.9	2.7	3.4	4.3	
15	0.0	0.0	0.0	0.0	0.0	0.0	0.0	
17	2.0	2.3	2.7	2.5	2.5	2.9	2.9	
19	1.7	1.4	1.6	1.9	1.6	1.8	1.8	
21	0.0	0.0	0.0	0.0	0.0	0.0	0.0	
23	1.2	1.3	1.5	1.5	1.1	1.4	1.6	
25	0.9	0.9	1.1	1.0	1.0	1.2	1.1	
27	0.0	0.0	0.0	0.0	0.0	0.0	0.0	
29	0.7	0.7	0.8	0.9	0.6	0.8	0.9	
31	0.5	0.6	0.7	0.7	0.6	0.7	0.8	
33	0.0	0.0	0.0	0.0	0.0	0.0	0.0	
35	0.5	0.4	0.5	0.6	0.4	0.5	0.6	
37	0.4	0.4	0.5	0.5	0.4	0.5	0.5	
39	0.0	0.0	0.0	0.0	0.0	0.0	0.0	
40	0.0	0.0	0.0	0.0	0.0	0.0	0.0	
41	0.4	0.3	0.3	0.4	0.3	0.4	0.4	
42	0.0	0.0	0.0	0.0	0.0	0.0	0.0	
43	0.3	0.3	0.3	0.3	0.3	0.3	0.4	
44	0.0	0.0	0.0	0.0	0.0	0.0	0.0	
45	0.0	0.0	0.0	0.0	0.0	0.0	0.0	
46	0.0	0.0	0.0	0.0	0.0	0.0	0.0	
47	0.3	0.2	0.2	0.3	0.2	0.3	0.3	
48	0.0	0.0	0.0	0.0	0.0	0.0	0.0	
49	0.2	0.2	0.2	0.3	0.2	0.2	0.3	
50	0.0	0.0	0.0	0.0	0.0	0.0	0.0	
Total RMS Current (A)	90.7	67.5	80.8	94.7	54.8	69.1	82.6	
THD (V) %	1.65	2.58	3.70	3.41	1.31	1.61	1.82	

Supply Harmonic Analysis (Frame F Normal Duty)

Assumptions: 10000A short circuit supply capability, equivalent to 73μH supply impedance at 400V where Q_{in} is the rated rms value of the fundamental voltage of the supply transformer. The results conform to stage 1, stage 2 and stage 3 of the Engineering Recommendation G.5/3 September 1976, Classification 'C': Limits for Harmonics in the UK Electricity Industry.

$$THD(V) \times 100 = \frac{\sqrt{\sum_{h=2}^{h=40} Q_{h^2}}}{Q_{in}} \%$$

Fundamental Voltage (V)	230			400				500		
Inverter Type	Three Phase									
Motor Power (kW)	30.0	37.0	45.0	55.0	75.0	90.0	90.0 (150HP)	55.0	75.0	90.0
Typical Motor Efficiency %	90	90	90	90	90	90	90	90	90	90
Harmonic No.	RMS Current (A)									
1	118.2	140.1	175.5	132.0	151.6	184.4	156.6	104.8	126.7	152.5
3	0.1	0.0	0.0	0.0	0.2	0.1	0.0	0.1	0.1	0.1
5	40.9	45.9	52.3	52.6	57.8	64.7	58.9	48.5	54.5	60.5
7	11.5	11.8	12.3	18.8	19.1	18.6	19.0	21.9	22.2	21.7
9	0.0	0.0	0.0	0.0	0.1	0.0	0.0	0.0	0.0	0.0
11	7.6	8.5	9.5	9.0	10.1	11.5	10.3	7.5	8.9	10.5
13	3.5	4.2	5.3	4.2	4.6	5.4	4.7	4.5	4.7	4.9
15	0.0	0.0	0.0	0.0	0.1	0.0	0.0	0.0	0.0	0.0
17	3.0	3.2	3.1	3.8	4.2	4.5	4.3	3.3	3.9	4.5
19	2.1	2.4	2.8	2.3	2.6	3.2	2.7	2.0	2.2	2.6
21	0.0	0.0	0.0	0.0	0.0	0.0	0.0	0.0	0.0	0.0
23	1.4	1.4	1.4	2.0	2.1	2.0	2.1	1.9	2.1	2.3
25	1.3	1.4	1.3	1.5	1.7	1.9	1.7	1.2	1.4	1.7
27	0.0	0.0	0.0	0.0	0.0	0.0	0.0	0.0	0.0	0.0
29	0.7	0.8	1.0	1.1	1.1	1.1	1.1	1.1	1.2	1.3
31	0.7	0.7	0.8	1.0	1.1	1.1	1.1	0.8	1.0	1.1
33	0.0	0.0	0.0	0.0	0.0	0.0	0.0	0.0	0.0	0.0
35	0.5	0.6	0.7	0.6	0.7	0.8	0.7	0.7	0.7	0.8
37	0.5	0.5	0.6	0.7	0.7	0.7	0.7	0.6	0.7	0.8
39	0.0	0.0	0.0	0.0	0.0	0.0	0.0	0.0	0.0	0.0
40	0.0	0.0	0.0	0.0	0.0	0.0	0.0	0.0	0.0	0.0
41	0.4	0.4	0.4	0.4	0.5	0.6	0.5	0.5	0.5	0.5
42	0.0	0.0	0.0	0.0	0.0	0.0	0.0	0.0	0.0	0.0
43	0.3	0.4	0.4	0.4	0.5	0.5	0.4	0.4	0.5	0.5
44	0.0	0.0	0.0	0.0	0.0	0.0	0.0	0.0	0.0	0.0
45	0.0	0.0	0.0	0.0	0.0	0.0	0.0	0.0	0.0	0.0
46	0.0	0.0	0.0	0.0	0.0	0.0	0.0	0.0	0.0	0.0
47	0.3	0.3	0.3	0.3	0.4	0.4	0.4	0.3	0.3	0.4
48	0.0	0.0	0.0	0.0	0.0	0.0	0.0	0.0	0.0	0.0
49	0.3	0.3	0.3	0.3	0.4	0.4	0.3	0.3	0.3	0.3
50	0.0	0.0	0.0	0.0	0.0	0.0	0.0	0.0	0.0	0.0
Total RMS Current (A)	125.9	148.2	183.9	143.8	163.8	196.8	168.9	118.0	140.2	166.0
THD (V) %	1.49	1.66	1.87	1.95	2.13	2.34	2.15	1.87	2.06	2.25

9-22 Technical Specifications

Supply Harmonic Analysis (Frame F Heavy Duty)

Assumptions: 10000A short circuit supply capability, equivalent to 73μH supply impedance at 400V where Q_{1n} is the rated rms value of the fundamental voltage of the supply transformer. The results conform to stage 1, stage 2 and stage 3 of the Engineering Recommendation G.5/3 September 1976, Classification 'C': Limits for Harmonics in the UK Electricity Industry.

$$THD(V) \times 100 = \sqrt{\frac{\sum_{h=2}^{h=40} Q_{h^2}}{Q_{1n}}} \%$$

Fundamental Voltage (V)	230			400				500		
Inverter Type	Three Phase									
Motor Power (kW)	30.0	37.0	45.0	55.0	75.0	90.0	90.0 (150HP)	55.0	75.0	90.0
Typical Motor Efficiency %	90	90	90	90	90	90	90	90	90	90
Harmonic No.	RMS Current (A)									
1	94.7	118.2	140.1	99.2	132.1	152.1	156.6	79.7	104.8	126.7
3	0.0	0.0	0.0	0.1	0.1	0.1	0.0	0.0	0.1	0.1
5	35.9	41.6	45.9	44.9	53.4	57.8	58.9	42.4	49.3	54.5
7	11.9	11.9	11.8	19.5	19.5	19.1	19.0	22.1	22.5	22.2
9	0.0	0.0	0.0	0.0	0.0	0.0	0.0	0.0	0.1	0.0
11	6.5	7.7	8.5	6.9	9.0	10.0	10.3	5.7	7.5	8.9
13	2.9	3.5	4.2	4.0	4.3	4.6	4.7	4.6	4.6	4.7
15	0.0	0.0	0.0	0.0	0.0	0.0	0.0	0.0	0.0	0.0
17	2.7	3.1	3.2	3.1	3.9	4.2	4.3	2.6	3.3	3.9
19	1.6	2.1	2.4	1.8	2.2	2.6	2.7	1.8	2.0	2.2
21	0.0	0.0	0.0	0.0	0.0	0.0	0.0	0.0	0.0	0.0
23	1.4	1.4	1.4	1.7	2.0	2.1	2.1	1.5	1.9	2.1
25	1.1	1.3	1.4	1.1	1.5	1.7	1.7	1.0	1.2	1.4
27	0.0	0.0	0.0	0.0	0.0	0.0	0.0	0.0	0.0	0.0
29	0.7	0.8	0.8	1.0	1.1	1.1	1.1	0.9	1.1	1.2
31	0.7	0.8	0.7	0.8	1.0	1.1	1.1	0.6	0.8	1.0
33	0.0	0.0	0.0	0.0	0.0	0.0	0.0	0.0	0.0	0.0
35	0.4	0.5	0.6	0.6	0.6	0.7	0.7	0.6	0.7	0.7
37	0.4	0.5	0.5	0.6	0.6	0.7	0.7	0.4	0.6	0.7
39	0.0	0.0	0.0	0.0	0.0	0.0	0.0	0.0	0.0	0.0
40	0.0	0.0	0.0	0.0	0.0	0.0	0.0	0.0	0.0	0.0
41	0.3	0.4	0.4	0.4	0.4	0.5	0.5	0.4	0.5	0.5
42	0.0	0.0	0.0	0.0	0.0	0.0	0.0	0.0	0.0	0.0
43	0.3	0.3	0.4	0.4	0.4	0.4	0.4	0.3	0.5	0.5
44	0.0	0.0	0.0	0.0	0.0	0.0	0.0	0.0	0.0	0.0
45	0.0	0.0	0.0	0.0	0.0	0.0	0.0	0.0	0.0	0.0
46	0.0	0.0	0.0	0.0	0.0	0.0	0.0	0.0	0.0	0.0
47	0.2	0.3	0.3	0.3	0.3	0.4	0.4	0.3	0.3	0.3
48	0.0	0.0	0.0	0.0	0.0	0.0	0.0	0.0	0.0	0.0
49	0.2	0.3	0.3	0.3	0.3	0.3	0.3	0.3	0.3	0.3
50	0.0	0.0	0.0	0.0	0.0	0.0	0.0	0.0	0.0	0.0
Total RMS Current (A)	102.3	126.2	148.2	110.9	144.3	164.3	168.9	93.3	118.4	140.2
THD (V) %	1.33	1.52	1.66	1.71	1.98	2.12	2.15	1.67	1.90	2.06

Chapter 10 CERTIFICATION FOR THE DRIVE

Requirements for EMC Compliance

All Variable Speed Drives (VSDs) potentially produce electrical emissions which are radiated into the environment and conducted back into the ac supply. VSDs are inherently immune to any additional external electrical noise. The following information is provided to maximise the Electro Magnetic Compatibility (EMC) of VSDs and systems in their intended operating environment, by minimising their emissions and maximising their immunity.

Minimising Radiated Emissions

EN50081-1 (1992)/EN50081-2 (1994)/EN55011/EN55022 radiated emission measurements are made between 30MHz and 1GHz in the far field at a distance of 10 to 30 metres. Limits lower than 30MHz or in close proximity are not specified. Emissions from individual components tend to be additive.

- Use a screened/armoured cable between VSD/cubicle and motor containing the motor protective earth (PE) connection. It should have a 360° screen termination. Earth screen at both ends connecting to the motor frame and cubicle (or gland box if wall mounted). Maintain the screen integrity using 360° terminations.

Note: *Some hazardous area installations may preclude direct earthing at both ends of the screen, in this case earth one end via a 1µF 50Vac capacitor, and the other as normal.*

- Keep unshielded cable as short as possible inside the cubicle.
- Always maintain the integrity of the shield.
- If the cable is interrupted to insert contactors etc., re-connect the screen using the shortest possible route.
- Keep the length of screen stripped-back as short as possible when making screen connections.
- Ideally use 360° screen terminations using cable glands or 'U' clips on power screen rails.

If a shielded cable is not available, lay unshielded motor cables in a metal conduit which will act as a shield. The conduit must be continuous with a direct electrical contact to the VSD and motor housing. If links are necessary, use braid with a minimum cross sectional area of 10mm².

Note: *Some motor gland boxes and conduit glands are made of plastic, if this is the case, then braid must be connected between the screen and the chassis. In addition at the motor end, ensure that the screen is electrically connected to the motor frame since some terminal boxes are insulated from the frame by gasket/paint.*

Earthing Requirements

IMPORTANT: Protective earthing always takes precedence over EMC earthing.

Protective Earth (PE) Connections

Note: *In accordance with installations to EN60204, only one protective earth conductor is permitted at each protective earth terminal contacting point.*

Local wiring regulations may require the protective earth connection of the motor to be connected locally, i.e. not as specified in these instructions. This will not cause shielding problems because of the relatively high RF impedance of the local earth connection.

EMC Earth Connections

For compliance with EMC requirements, we recommend that the "0V/signal ground" is separately earthed. When a number of units are used in a system, these terminals should be connected together at a single, local earthing point.

10-2 Certification for the Drive

Control and signal cables for the encoder, all analog inputs, and communications require screening with the screen connected only at the VSD end. However, if high frequency noise is still a problem, earth screen at the non VSD end via a 0.1 μ F capacitor.

Note: Connect the screen (at the VSD end) to the VSD protective earth point, and not to the control board terminals.

Cabling Requirements

Note: Refer to Chapter 9: "Technical Specifications" for additional Cabling Requirements.

Planning Cable Runs

- Use the shortest possible motor cable lengths.
- Use a single length of cable to a star junction point to feed multiple motors.
- Keep electrically noisy and sensitive cables apart.
- Keep electrically noisy and sensitive parallel cable runs to a minimum. Separate parallel cable runs by at least 0.25 metres. For runs longer than 10 metres, separation should be increased proportionally. For example if the parallel runs were 50m, then the separation would be $(50/10) \times 0.25\text{m} = 1.25\text{m}$.
- Sensitive cables should cross noisy cables at 90°.
- Never run sensitive cables close or parallel to the motor, dc link and braking chopper circuit for any distance.
- Never run supply, dc link or motor cables in the same bundle as the signal/control and feedback cables, even if they are screened.
- Ensure EMC filter input and output cables are separately routed and do not couple across the filter.

Increasing Motor Cable Length

Because cable capacitance and hence conducted emissions increase with motor cable length, conformance to EMC limits is only guaranteed with the specified ac supply filter option using a maximum cable length as specified in Chapter 11: "Technical Specifications".

This maximum cable length can be improved using the specified external input or output filters. Refer to Chapter 9: "Technical Specifications" - External AC Supply (RFI) Filters.

Screened/armoured cable has significant capacitance between the conductors and screen which increases linearly with cable length (typically 200pF/m but varies with cable type and current rating).

Long cable lengths may have the following undesirable effects:

- Tripping on 'overcurrent' as the cable capacitance is charged and discharged at the switching frequency.
- Producing increased conducted emissions which degrade the performance of the EMC filter due to saturation.
- Causing RCDs (Residual Current Devices) to trip due to increased high frequency earth current.
- Producing increased heating inside the EMC ac supply filter from the increased conducted emissions.

These effects can be overcome by adding chokes or output filters at the output of the VSD.

EMC Installation Options

The unit, when installed for Class A or Class B operation, will be compliant with EN55011 (1991)/ EN55022 (1994) for radiated emissions, as described below.

Screening & Earthing (wall mounted, Class A)

IMPORTANT: This unit must be fitted with the optional top cover.

The unit is installed for Class A operation when wall mounted using the recommended ac supply filter and having complied with all cabling requirements.

Note: *The installation requirements of local safety standards must be achieved regarding the safety of electrical equipment for machines.*

- A single-star point earthing policy as shown in Figure 10-2 is required.
- The protective earth connection (PE) to the motor must be run inside the screened cable between the motor and VSD and be connected to the protective earth terminal in the gland box, or on the VSD.
- The external ac supply filter must be permanently earthed. Refer to Chapter 9: “Technical Specifications” - Earthing/Safety Details.
- The signal/control cables should be screened.

Note: *Refer to Chapter 9: “Technical Specifications” for details on Cabling Requirements.*

Screening & Earthing (cubicle mounted, Class B)

Note: *The installation requirements of local safety standards must be achieved regarding the safety of electrical equipment for machines. Refer to Chapter 3: “Installing the Drive” - Protective Earth (PE) Connections .*

The unit is installed for Class B operation when mounted inside a cubicle having 10dB attenuation between 30 and 100MHz (typically the attenuation provided by a metal cabinet with no aperture of dimension greater than 0.15m), using the recommended ac supply filter and having met all cabling requirements.

Note: *Radiated magnetic and electric fields inside the cubicle will be high and any components fitted inside must be sufficiently immune.*

The VSD, external filter and associated equipment are mounted onto a conducting, metal mounting panel. Do not use cubicle constructions that use insulating mounting panels or undefined mounting structures. Cables between the VSD and motor must be screened or armoured and terminated at the VSD or locally on the back panel.

10-4 Certification for the Drive

Single VSD - Single Motor

Apply a single point series earthing strategy for a single VSD mounted in a cubicle as shown.

The protective earth connection (PE) to the motor must be run inside the screened cable between the motor and VSD and be connected to the motor protective earth terminal on the VSD.

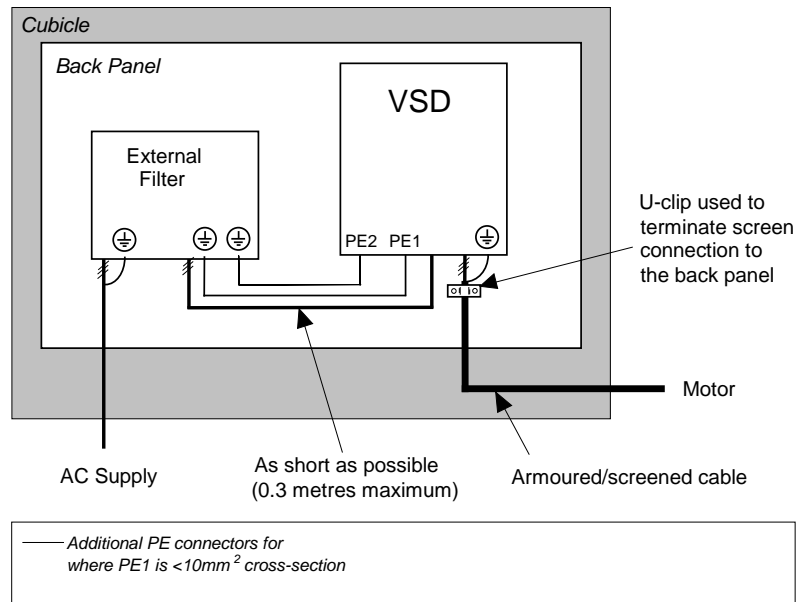

Figure 10-1 EMC and Safety Earthing Cabling

Single VSD - Multiple Motors

Note: Refer to Chapter 11: "Application Notes" - Using Multiple Motors on a Single Drive.

If connecting multiple motors to a single VSD, use a star junction point for motor cable connections. Use a metal box with entry and exit cable glands to maintain shield integrity. Refer to Chapter 11: Application Notes" - Using Multiple Motors on a Single Drive.

Star Point Earthing

A star-point earthing policy separates 'noisy' and 'clean' earths. Four separate earth busbars (three are insulated from the mounting panel) connect to a single earth point (star point) near the incoming safety earth from the main supply. Flexible, large cross-section cable is used to ensure a low HF impedance. Busbars are arranged so that connection to the single earth point is as short as possible.

1 Clean Earth Busbar (insulated from the mounting panel)

Used as a reference point for all signal and control cabling. This may be further subdivided into an analog and a digital reference busbar, each separately connected to the star earthing point. The digital reference is also used for any 24V control.

Note: The 690V uses a single clean earth busbar for analog and digital.

2 Dirty Earth Busbar (insulated from the mounting panel)

Used for all power earths, i.e. protective earth connection. It is also used as a reference for any 110 or 220V control used, and for the control transformer screen.

3 Metal Work Earth Busbar

The back panel is used as this earth busbar, and should provide earthing points for all parts of the cubicle including panels and doors. This busbar is also used for power screened cables which terminate near to (10cm) or directly into a VSD - such as motor cables, braking choppers and their resistors, or between VSDs - refer to the appropriate product manual to identify these. Use U-clips to clamp the screened cables to the back panel to ensure optimum HF connection.

4 Signal/Control Screen Earth Busbar (insulated from the mounting panel)

Used for signal/control screened cables which **do not** go directly to the VSD. Place this busbar as close as possible to the point of cable entry. 'U' clamp the screened cables to the busbars to ensure an optimum HF connection.

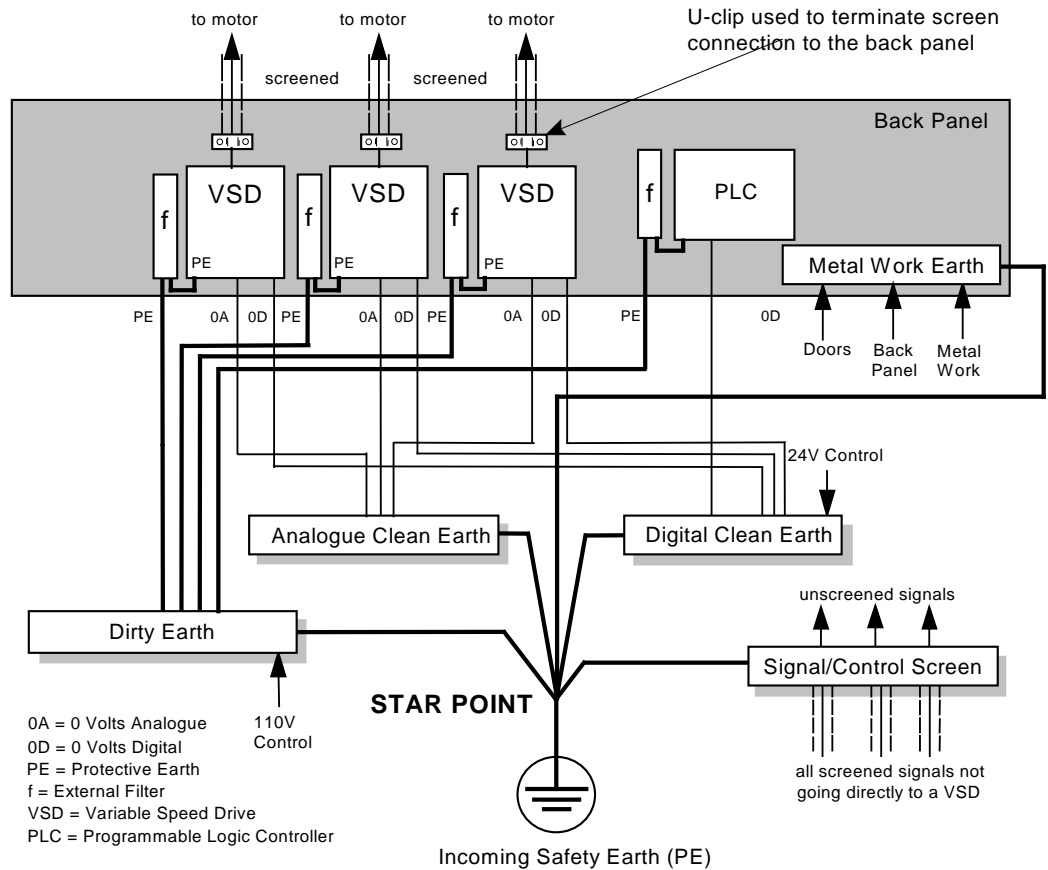

Figure 10-2 Star Point Earthing

Sensitive Equipment

The proximity of the source and victim circuit has a large effect on radiated coupling. The electromagnetic fields produced by VSDs falls off rapidly with distance from the cabling/cubicle. Remember that the radiated fields from EMC compliant drive systems are measured at least 10m from the equipment, over the band 30-1000MHz. Any equipment placed closer than this will see larger magnitude fields, especially when very close to the drive.

Do not place magnetic/electric field sensitive equipment within 0.25 metres of the following parts of the VSD system:

- Variable Speed Drive (VSD)
- EMC output filters
- Input or output chokes/transformers
- The cable between VSD and motor (even when screened/armoured)
- Connections to external braking chopper and resistor (even when screened/armoured)
- AC/DC brushed motors (due to commutation)
- DC link connections (even when screened/armoured)
- Relays and contactors (even when suppressed)

From experience, the following equipment is particularly sensitive and requires careful installation.

- Any transducers which produce low level analog outputs (<1V), e.g. load cells, strain gauges, thermocouples, piezoelectric transducers, anemometers, LVDTs
- Wide band width control inputs (>100Hz)
- AM radios (long and medium wave only)
- Video cameras and closed circuit TV
- Office personal computers
- Capacitive devices such as proximity sensors and level transducers
- Mains borne communication systems
- Equipment not suitable for operation in the intended EMC environment, i.e. with insufficient immunity to new EMC standards

10-6 Certification for the Drive

Requirements for UL Compliance

Solid-State Motor Overload Protection

These devices provide Class 10 motor overload protection. The maximum internal overload protection level (current limit) is 150% for 60 seconds in Heavy Duty mode, and 110% for 60s in Normal Duty mode. Refer to the Software Product Manual, Chapter 1: Programming Your Application - CURRENT LIMIT for user current limit adjustment information.

An external motor overload protective device must be provided by the installer where the motor has a full-load ampere rating of less than 50% of the drive output rating; or when the DISABLE STALL trip (^SSTLL) is set to True (1); or when the STALL TIME parameter is increased above 480 seconds (refer to the 650V Software Manual, Chapter 1 : STALL TRIP.

Motor over temperature sensing is required. Motors used in conjunction with the drive controller shall be provided with PTC sensor(s) or relays suitable for use with the variable speed drive. Technical details can be found in Chapter 3 Installing the Drive.

Short Circuit Rating

The following drives are suitable for use on a circuit capable of delivering not more than:

Frame C: 10,000 RMS Symmetrical Amperes, 230/460/500V maximum (as appropriate)

Frame D: 10,000 RMS Symmetrical Amperes, 230/460/500V maximum (as appropriate)

Frame E: 18,000 RMS Symmetrical Amperes, 230/460/500V maximum (as appropriate)

Frame F: 18,000 RMS Symmetrical Amperes, 230/460/500V maximum (as appropriate)

Solid-State Short-Circuit Protection

These devices are provided with Solid-State Short-Circuit (output) Protection. Branch circuit protection requirements must be in accordance with the latest edition of the National Electrical Code NEC/NFPA-70.

Recommended Branch Circuit Protection

It is recommended that UL Listed (JDDZ) non-renewable cartridge fuses, Class K5 or H; or UL Listed (JDRX) renewable cartridge fuses, Class H, are installed upstream of the drive. Refer to Chapter 9: "Technical Specifications" - Power Details for recommended fuse ratings.

Motor Base Frequency

The motor base frequency rating is 480Hz maximum.

Field Wiring Temperature Rating

Use 75°C Copper conductors only.

Field Wiring Terminal Markings

For correct field wiring connections that are to be made to each terminal refer to Chapter 3: "Installing the Drive" - Power Wiring Connections, and Control Wiring Connections.

Terminal Tightening Torques

Refer to Chapter 3: "Installing the Drive" - Terminal Tightening Torques.

Recommended Wire Sizes

North American wire sizes (AWG) are based on NEC/NFPA-70 for ampacities of thermoplastic-insulated (75°C) copper conductors assuming not more than three current-carrying conductors in raceway or cable, based on ambient temperature of 30°C.

The wire sizes allow for an ampacity of 125% of the rated input and output amperes for motor branch-circuit conductors as specified in NEC/NFPA-70.

FRAME C			
Terminal acceptance range: 18-6 AWG			
Model Catalog Code for North America	Power Input AWG	Power Output AWG	Brake Output AWG
230V Build Variant: 220-240V ±10%			
HEAVY DUTY			
650V/0007/230/..	8	10	8
650V/0010/230/..	8	8	12
NORMAL DUTY			
650V/0007/230/..	8	8	14
650V/0010/230/..	6	6	14
400V Build Variant: 460V ±10%			
HEAVY DUTY			
650V/0007/460/..	12	14	14
650V/0010/460/..	12	12	12
650V/0015/460/..	10	10	12
650V/0020/460/..	8	8	12
NORMAL DUTY			
650V/0007/460/..	12	12	14
650V/0010/460/..	10	10	12
650V/0015/460/..	8	8	12
650V/0020/460/..	8	8	12

FRAME D			
Terminal acceptance range: 14-4 AWG			
Model Catalog Code for North America	Power Input AWG	Power Output AWG	Brake Output AWG
230V Build Variant: 220-240V ±10%			
HEAVY DUTY			
650V/0015/230/..	6	6	10
650V/0020/230/..	4	4	10
650V/0025/230/..	4	4	10
NORMAL DUTY			
650V/0015/230/..	4	4	10
650V/0020/230/..	4	4	10
400V Build Variant: 460V ±10%			
HEAVY DUTY			
650V/0020/460/..	8	10	10
650V/0025/460/..	8	8	10
650V/0030/460/..	8	6	10
650V/0040/460/..	4	6	10
NORMAL DUTY			
650V/0020/460/..	8	8	10
650V/0025/460/..	8	6	10
650V/0030/460/..	6	6	10
650V/0040/460/..	4	4	10

10-8 Certification for the Drive

FRAME E			
Terminal acceptance range: 6-1/0 AWG			
Model Catalog Code for North America	Power Input AWG	Power Output AWG	Brake Output AWG
230V Build Variant: 220-240V ±10%			
HEAVY DUTY			
650V/0030/230/..	2	3	6
NORMAL DUTY			
650V/0030/230/..	1/0	1	6
400V Build Variant: 460V ±10%			
HEAVY DUTY			
650V/0040/460/..	4	4	8
650V/0050/460/..	4	3	6
650V/0060/460/..	3	2	4
NORMAL DUTY			
650V/0040/460/..	4	3	8
650V/0050/460/..	3	2	6
650V/0060/460/..	1	1	4

FRAME F			
Terminal acceptance range: 2AWG-250kcmil			
Model Catalog Code for North America	Power Input AWG	Power Output AWG	Brake Output AWG
230V Build Variant: 220-240V ±10%			
HEAVY DUTY			
650V/0040/230/..	1	1	4
650V/0050/230/..	2/0	2/0	3
650V/0060/230/..	3/0	3/0	2
NORMAL DUTY			
650V/0040/230/..	2/0	2/0	4
650V/0050/230/..	3/0	3/0	3
650V/0060/230/..	4/0	250kcmil	2
400V Build Variant: 460V ±10%			
HEAVY DUTY			
650V/0075/460/..	1	1	4
650V/0100/460/..	2/0	2/0	2
650V/0125/460/..	3/0	3/0	1
650V/0150/460/..	4/0	4/0	1
NORMAL DUTY			
650V/0075/460/..	2/0	2/0	4
650V/0100/460/..	3/0	3/0	2
650V/0125/460/..	4/0	4/0	1
650V/0150/460/..	4/0	4/0	1

Field Grounding Terminals

The field grounding terminals are identified with the International Grounding Symbol (IEC Publication 417, Symbol 5019).



Operating Ambient Temperature

Heavy duty devices are considered acceptable for use in a maximum ambient temperature of 45°C (40°C for models with a Type 1 Enclosure). Normal duty devices are considered suitable for use in:

- a maximum ambient temperature of 40°C for both 'open type' and Type 1 Enclosed models
- a maximum ambient temperature of 35°C when fitted with the UL Type 1 top cover in Constant operation

Direct Wall-Mountable Models

All models of this drive with a Product Code Block 4 (Frames C, D, E) designation xx2x are suitable for direct wall mounting applications as they have a "Type 1 Enclosure" rating.

In order to preserve this enclosure rating, it is important to maintain the environmental integrity of the enclosure. Therefore, the installer must provide correct Type 1 closures for all unused clearance holes provided within the drive's glandplate.

Type 1 Enclosed models are suitable for use in no worse than a Pollution Degree 2 environment.

Input Fuse Ratings (North America)						
Catalog Number	Input Fuse Rating (A)		Catalog Number	Input Fuse Rating (A)		
	HEAVY DUTY	NORMAL DUTY		HEAVY DUTY	NORMAL DUTY	
230V BUILD VARIANT 220-240V ±10%, 45-65Hz *						
Frame C			Frame E			
650V/0007/230..	30	35	650V/0030/230..	100	125	
650V/0010/230..	35	50				
Frame D			Frame F			
650V/0015/230..	50	60	650V/0040/230..	110	150	
650V/0020/230..	60	70	650V/0050/230..	150	150	
650V/0025/230..	70	-	650V/0060/230..	150	200	
400V BUILD VARIANT 380-460V ±10%, 45-65Hz *						
Frame C			Frame E			
650V/0007/460/..	15	20	650V/0040/460/..	60	70	
650V/0010/460/..	20	25	650V/0050/460/..	70	90	
650V/0015/460/..	25	30	650V/0060/460/..	90	100	
650V/0020/460/..	35	40				
Frame D			Frame F			
650V/0020/460/..	30	40	650V/0075/460/..	110	125	
650V/0025/460/..	40	45	650V/0100/460/..	125	150	
650V/0030/460/..	45	60	650V/0125/460/..	150	175	
650V/0040/460/..	60	70	650V/0150/460/..	175	175	

10-10 Certification for the Drive

European Directives and the CE Mark

The following information is supplied to provide a basic understanding of the low voltage directives CE marking requirements. The following literature is recommended for further information:

- *Recommendations for Application of Power Drive Systems (PDS), European Council Directives - CE Marking and Technical Standardisation - (CEMEP)*

Available from your local trade association or Parker SSD Drives office

The European machines and drives manufacturers via their national trade associations have formed the European Committee of Manufacturers of Electrical Machines and Power Electronics (CEMEP). Parker SSD Drives and other major European drives manufacturers are working to the CEMEP recommendations on CE marking. The CE mark shows that a product complies with the relevant EU directives, in our case the Low Voltage Directive and, in some instances, the EMC Directive.

CE Marking for Low Voltage Directive

When installed in accordance with this manual, the 650V AC Drive is CE marked by Parker SSD Drives in accordance with the low voltage directive (S.I. No. 3260 implements this LVD directive into UK law). An EC Declaration of Conformity (low voltage directive) is included at the end of this chapter.

CE Marking for EMC - Who is Responsible?

Note: *The specified EMC emission and immunity performance of this unit can only be achieved when the unit is installed to the EMC Installation Instructions given in this manual.*

According to S.I. No. 2373 which implements the EMC directive into UK law, the requirement for CE marking this unit falls into two categories:

1. Where the supplied unit has an intrinsic/direct function to the end user, then the unit is classed as **relevant apparatus**.
2. Where the supplied unit is incorporated into a higher system/apparatus or machine which includes (at least) the motor, cable and a driven load but is unable to function without this unit, then the unit is classed as a **component**.

n **Relevant Apparatus - Parker SSD Drives Responsibility**

Occasionally, say in a case where an existing fixed speed motor - such as a fan or pump - is converted to variable speed with an add-on drive module (*relevant apparatus*), it becomes the responsibility of Parker SSD Drives to apply the CE mark and issue an EC Declaration of Conformity for the EMC Directive. This declaration and the CE mark is included at the end of this chapter.

n **Component - Customer Responsibility**

The majority of Parker SSD Drives' products are classed as *components* and therefore we cannot apply the CE mark or produce an EC Declaration of Conformity in respect of EMC. It is therefore the manufacturer/supplier/installer of the higher system/apparatus or machine who must conform to the EMC directive and CE mark.

Legal Requirements for CE Marking

IMPORTANT: Before installation, clearly understand who is responsible for conformance with the EMC directive. Misappropriation of the CE mark is a criminal offence.

It is important that you have now defined who is responsible for conforming to the EMC directive, either:

n Parker SSD Drives Responsibility

You intend to use the unit as *relevant apparatus*.

When the specified EMC filter is correctly fitted to the unit following EMC installation instructions, it complies with the relevant standards indicated in the following tables. The fitting of the filter is mandatory for the CE marking of this unit to apply.

The relevant declarations are to be found at the end of this chapter. The CE mark is displayed on the EC Declaration of Conformity (EMC Directive) provided at the end of this chapter.

n Customer Responsibility

You intend to use the unit as a *component*, therefore you have a choice:

1. To fit the specified filter following EMC installation instructions, which may help you gain EMC compliance for the final machine/system.
2. Not to fit the specified filter, but use a combination of global or local filtering and screening methods, natural migration through distance, or the use of distributed parasitic elements of the existing installation.

Note: *When two or more EMC compliant components are combined to form the final machine/system, the resulting machine/system may no longer be compliant, (emissions tend to be additive, immunity is determined by the least immune component). Understand the EMC environment and applicable standards to keep additional compliance costs to a minimum.*

Applying for CE Marking for EMC

We have supplied a Manufacturer's EMC Declaration at the end of this chapter that you can use as a basis for your own justification of overall compliance with the EMC directive. There are three methods of demonstrating conformity:

1. Self-certification to a relevant standard
2. Third party testing to a relevant standard
3. Writing a technical construction file stating the technical rationale as to why your final machine/system is compliant. An EMC "competent body" must then assess this and issue a technical report or certificate to demonstrate compliance.
Refer to 2004/108/EC.

With EMC compliance, an EC Declaration of Conformity and the CE mark will be issued for your final machine/system.

IMPORTANT: Professional end users with EMC expertise who are using drive modules and cubicle systems defined as components who supply, place on the market or install the relevant apparatus must take responsibility for demonstrating EMC conformance and applying the CE mark and issuing an EC Declaration of Conformity.

Which Standards Apply?

Power Drive Product Specific

The standards that may apply to this unit come under two broad categories:

1. Emission - these standards limit the interference caused by operating (this) drive module.
2. Immunity - these standards limit the effect of interference (on this unit) from other electrical and electronic apparatus.

Conformance can be demonstrated using the Product Specific Standard.

10-12 Certification for the Drive

Certificates

652V



EC DECLARATIONS OF CONFORMITY

Date CE marked first applied: 01.04.2000

EMC Directive

In accordance with the EEC Directive
2004/108/EC

We Parker SSD Drives, address as below, declare under our sole responsibility that the above Electronic Products when installed and operated with reference to the instructions in the Product Manual (provided with each piece of equipment) is in accordance with the relevant clauses from the following standard:-

* BSEN61800-3 (2004)

Low Voltage Directive

In accordance with the EEC Directive
2006/95/EC

We Parker SSD Drives, address as below, declare under our sole responsibility that the above Electronic Products when installed and operated with reference to the instructions in the Product Manual (provided with each piece of equipment), is in accordance with the relevant clauses from the following standard :-

EN50178 (1998)

Issued for compliance with the EMC Directive when the unit is used as *relevant apparatus*.

The drive is CE marked in accordance with the low voltage directive for electrical equipment and appliances in the voltage range when installed correctly.

MANUFACTURERS DECLARATIONS

EMC Declaration

We Parker SSD Drives, address as below, declare under our sole responsibility that the above Electronic Products when installed and operated with reference to the instructions in the Product Manual (provided with each piece of equipment) is in accordance with the relevant clauses from the following standard:-

* BSEN61800-3 (2004)

Machinery Directive

The above Electronic Products are components to be incorporated into machinery and may not be operated alone. The complete machinery or installation using this equipment may only be put into service when the safety considerations of the Directive 2006/42/EC are fully adhered to.

Particular reference should be made to EN60204-1 (Safety of Machinery - Electrical Equipment of Machines).

All instructions, warnings and safety information of the Product Manual must be adhered to.

This is provided to aid your justification for EMC compliance when the unit is used as a *component*.

Since the potential hazards are mainly electrical rather than mechanical, the drive does not fall under the machinery directive. However, we do supply a manufacturer's declaration for when the drive is used (as a *component*) in machinery.

Dr Martin Payn (Conformance Officer)

* Compliant with the immunity requirements of the Standard without specified EMC filters.

Parker Hannifin Ltd., Automation Group, SSD Drives Europe

NEW COURTWICK LANE, LITTLEHAMPTON, WEST SUSSEX BN17 7RZ

TELEPHONE: +44(0)1903 737000 FAX: +44(0)1903 737100

Registered Number: 4806503 England. Registered Office: 55 Maylands Avenue, Hemel Hempstead, Herts HP2 4SJ

Chapter 11 APPLICATION NOTES

Application advice is available through our Technical Support Department, who can also arrange for on-site assistance if required. Refer to the back cover of this manual for the address of your local Parker SSD Drives company.

- Always use gold flash relays, or others designed for low current operation (5mA), on all control wiring.
- Remove all power factor correction equipment from the motor side of the drive before use.
- Avoid using motors with low efficiency and small $\cos \phi$ (power factor) as they require a larger kVA rated drive to produce the correct shaft kW.

Synchronous Motor Control

Although intended primarily for use with induction (asynchronous) motors, drives can also be used for speed control of synchronous motors. Synchronous motors can offer economic solutions in applications where tight control of speed is required together with the low maintenance characteristics of an ac motor.

The two most common types of synchronous ac motor are *permanent magnet* and *wound rotor*.

In contrast to induction motors, synchronous motors run at synchronous speed whether on full load or no load. Synchronous speed is set by the frequency of the supply applied to the stator. The stator flux can be kept constant by keeping the stator volts/frequency ratio constant, as with an induction motor.

Torque is produced in the motor by an increase in load angle between the stator and rotor fluxes. Maximum torque occurs when the load angle approaches 90° . If the load angle exceeds this value then torque drops and the motor will stall. Systems involving synchronous motors need careful design to ensure that the motor can accelerate the load and handle transient load changes without stalling.

Using Line Chokes

Line chokes are not required to limit input current to Parker SSD Drives drives. All 650V Frame C-F drives are fitted with DC link chokes to limit the ripple current seen by the DC link capacitors and thus prolong their life.

Line chokes may be used to reduce the harmonic content of the supply current where this is a particular requirement of the application or where greater protection from mains borne transients is required.

Using Output Contactors

The use of output contactors is permitted. It is recommended that this type of operation be limited to emergency use only or in a system where the drive can be inhibited before closing or opening this contactor.

Using Motor Chokes

Installations with motor cable runs in excess of 50m may suffer from nuisance overcurrent trips. This is due to the capacitance of the cable causing current spikes to be drawn from the drive output. A choke may be fitted in the drive output which limits the capacitive current. Screened cable has a higher capacitance and may cause problems in shorter runs. The recommended choke values are shown in Table 10.1.

11-2 Application Notes

Motor Power (kW)	Choke Inductance	RMS Current Rating	Parker SSD Part No.
0.75	2mH	7.5A	CO055931
1.1			
1.5			
2.2			
4.0	0.9mH	22A	CO057283
5.5			
7.5			
11	0.45mH	33A	CO057284
15			
18	0.3mH	44A	CO057285
22	50uH	70A	CO055193
30			
37	50uH	99A	CO055253
45	50uH	99A	CO055253
55	25uH	120A	-
75	25uH	160A	-
90	25uH	200A	-

Table 10-1 Recommended Choke Values for Cables up to 300 Metres

Chapter 12 SERIAL COMMUNICATIONS

Connection to the P3 Port

The port is an un-isolated RS232, 19200 Baud, supporting the standard EI bisynch ASCII communications protocol. Contact Parker SSD Drives for further information.

- **Frame C, D, E & F** : There are two ports - one is used by the Keypad, and the second is under the terminal cover to the right of the Control Terminals.

Using any P3 port on the drive, parameters can be monitored and updated by a suitable PC programming tool, i.e. DSE Lite.

P3 Port

A standard P3 lead is used to connect to the drive.

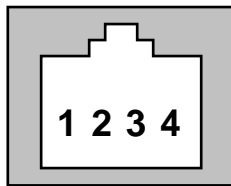

P3 Port Pin	Lead	Signal
1	Black	0V
2	Red	5V
3	Green	TX
4	Yellow	RX

6-Way Lead to DB9/DB25 Connector

Note: There is 5V present on pin 2 of the P3 port - do not connect this to your PC.

P3 Port Pin	Lead	Female DB9 Pin	Female DB25 Pin
1	Black	5	7
2	Red	not connected	not connected
3	Green	2	3
4	Yellow	3	2

Chapter 13 APPLICATIONS

The Default Application

The drive is supplied with 6 Applications, Application 0 to Application 5. Each Application recalls a pre-programmed structure of internal links when it is loaded.

DEFAU

- Application 0 will not control a motor. Loading Application 0 removes all internal links.
- Application 1 is the factory default application, providing for basic speed control
- Application 2 supplies speed control using a manual or auto setpoint
- Application 3 supplies speed control using preset speeds
- Application 4 is a set-up providing speed control with Raise/Lower Trim
- Application 5 supplies speed control with Run Forward/Run Reverse

IMPORTANT: Refer to Chapter 5: The Keypad – Special Menu Features to reset the drive to factory default values which are suitable for most applications.

How to Load an Application

In the **PRF** menu, go to **P I** and press the **M** key twice.

The Applications are stored in this menu.

Use the **▲** **▼** keys to select the appropriate Application by number.

Press the **E** key to load the Application.

Application Description

Control Wiring for Applications

The large Application Diagrams on the following pages show the full wiring for push-button starting. The diagrams on the reverse show the full wiring for single wire starting.

For the minimum connections to make the drive run refer to Chapter 3: "Installing the Drive" - Electrical Installation; the remaining connections can be made to suit your system.

When you load an Application, the input and output parameters shown in these diagrams default to the settings shown. For alternative user-settings refer to the Software Product Manual, Chapter 1 "Programming Your Application".

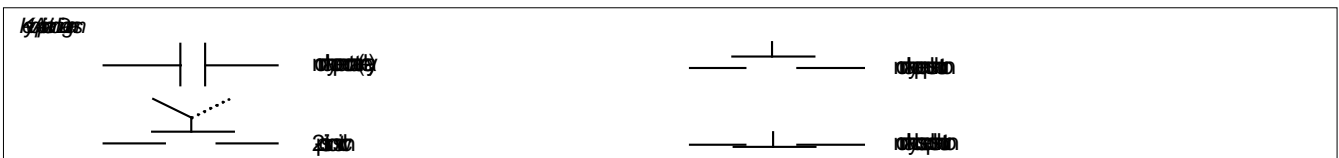

Application 1 : Basic Speed Control (default)

Application 1: Basic Speed Control

IDEAL FOR GENERAL PURPOSE APPLICATIONS,
NORMAL DUTY AND HEAVY DUTY

- STANDARD PARAMETERS**
- p1 Application
 - p2 Max speed
 - p3 Min speed
 - p4 Accel time
 - p5 Decel time
 - p6 Motor current
 - p7 Base frequency
 - p8 Jog setpoint
 - p9 Run stop mode
 - p11 V/F shape
 - p12 Normal duty
 - p13 Fixed boost, (VF only)
 - p99 Password

- DIAGNOSTICS**
- Frequency Hz
 - Speed Setpoint %
 - DC Link Volts V
 - Motor Current A

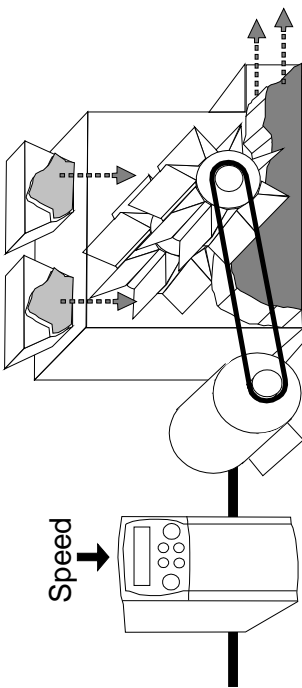

P I = 1

Italic text indicates Default

User Relay **5OP3 I** = 1

PUSH-BUTTON STARTING

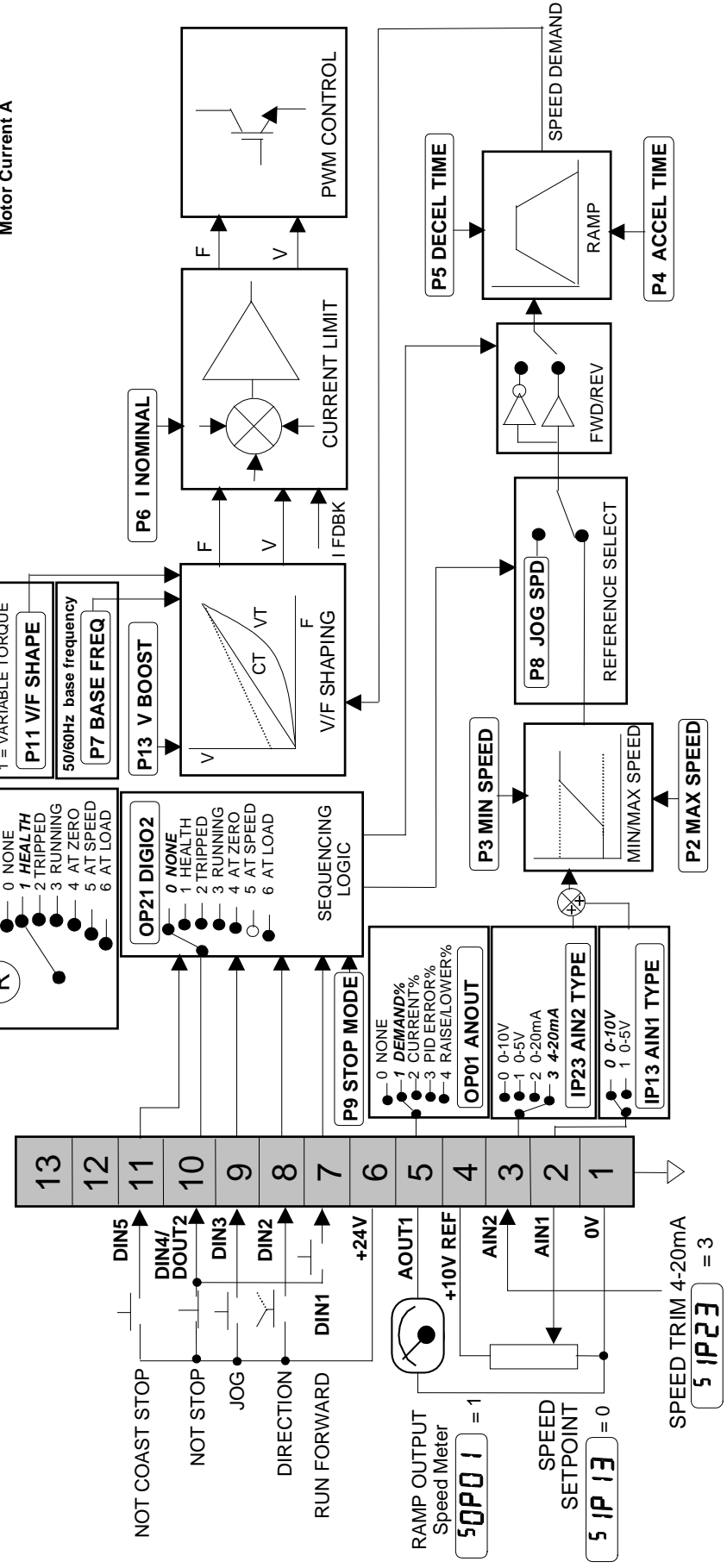

13-3 Applications

Application 1: Basic Speed Control (default)

This Application is ideal for general purpose applications. It provides push-button or switched start/stop control. The setpoint is the sum of the two analogue inputs AIN1 and AIN2, providing Speed Setpoint + Speed Trim capability.

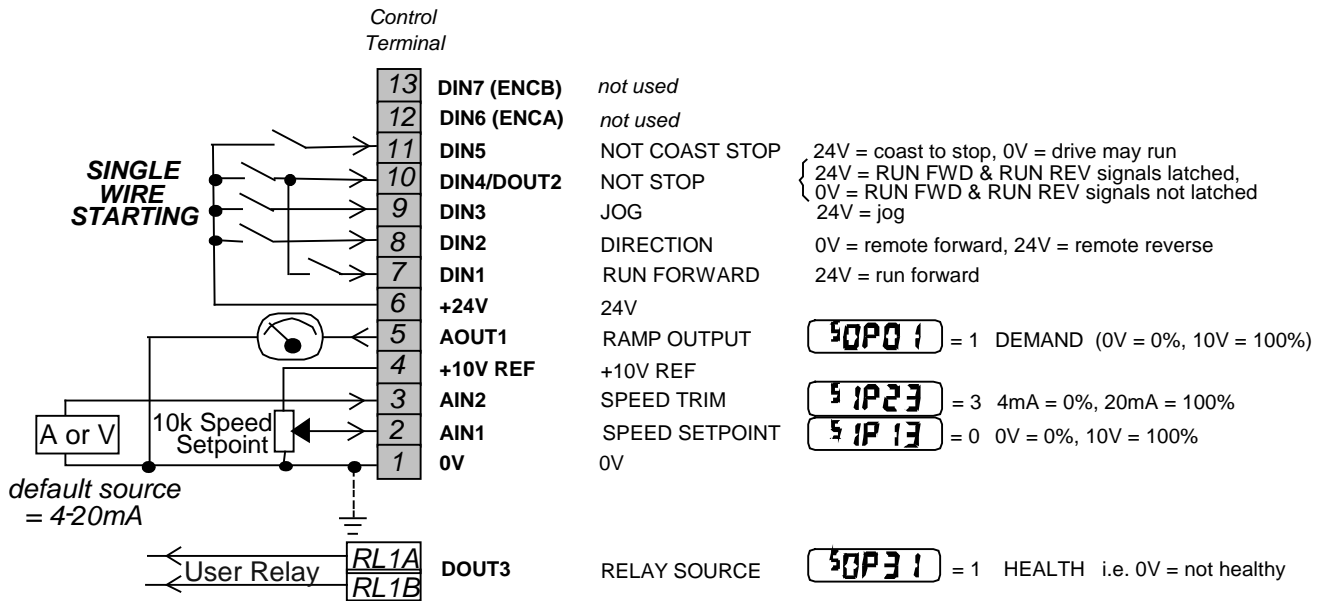

Application 2 : Auto/Manual Control

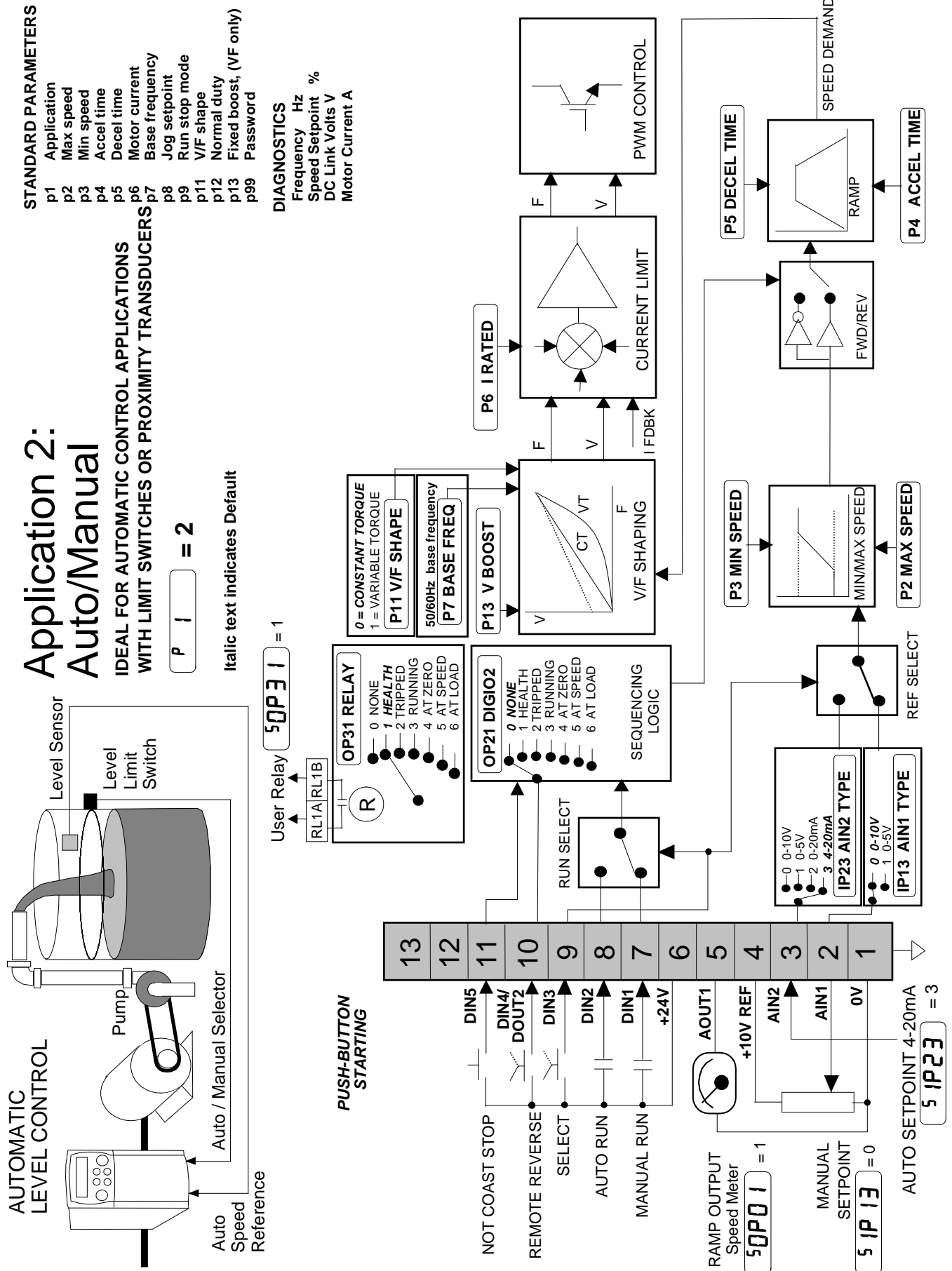

13-5 Applications

Application 2: Auto/Manual Control

Two Run inputs and two Setpoint inputs are provided. The Auto/Manual switch selects which pair of inputs is active. The Application is sometimes referred to as Local/Remote.

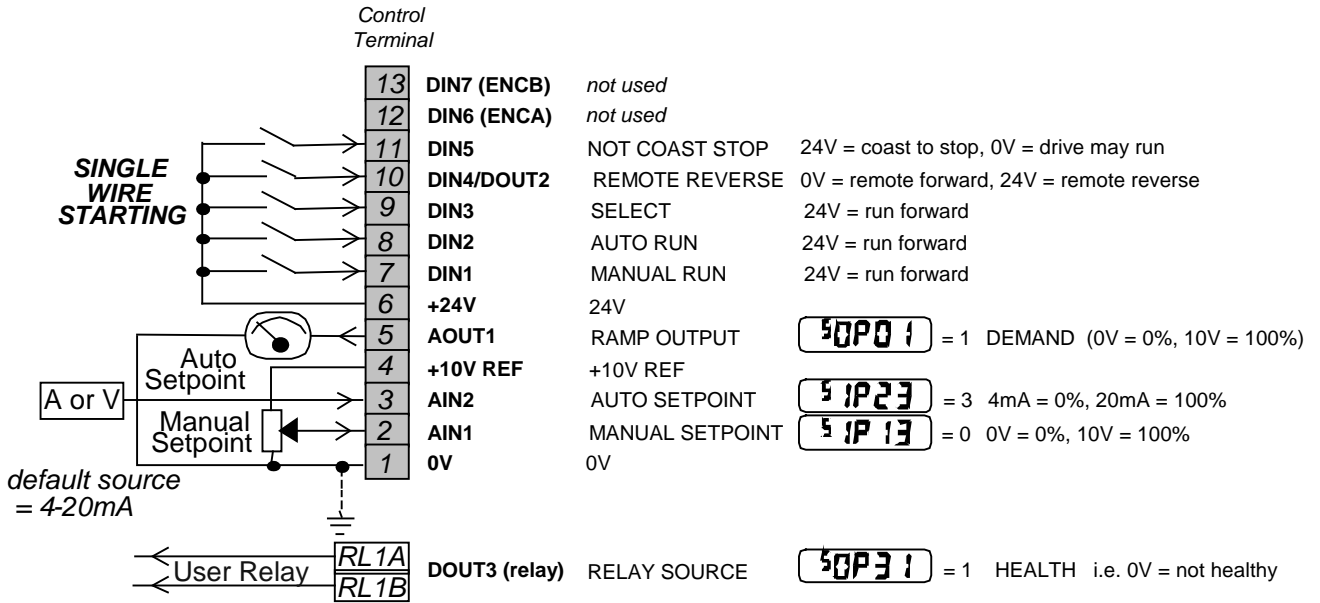

Application 3 : Preset Speeds

STANDARD PARAMETERS

- p1 Application
- p2 Max speed
- p3 Min speed
- p4 Accel time
- p5 Decel time
- p6 Motor current
- p7 Base frequency
- p8 Jog setpoint
- p9 Run stop mode
- p11 V/F shape
- p12 Normal duty
- p13 Fixed boost, (VF only)
- p99 Password

DIAGNOSTICS

- Frequency Hz
- Speed Setpoint %
- DC Link Volts V
- Motor Current A

Application 3: Preset Speeds

IDEAL FOR APPLICATIONS REQUIRING
 MULTIPLE DISCRETE SPEED LEVELS

P I = 3

Italic text indicates Default

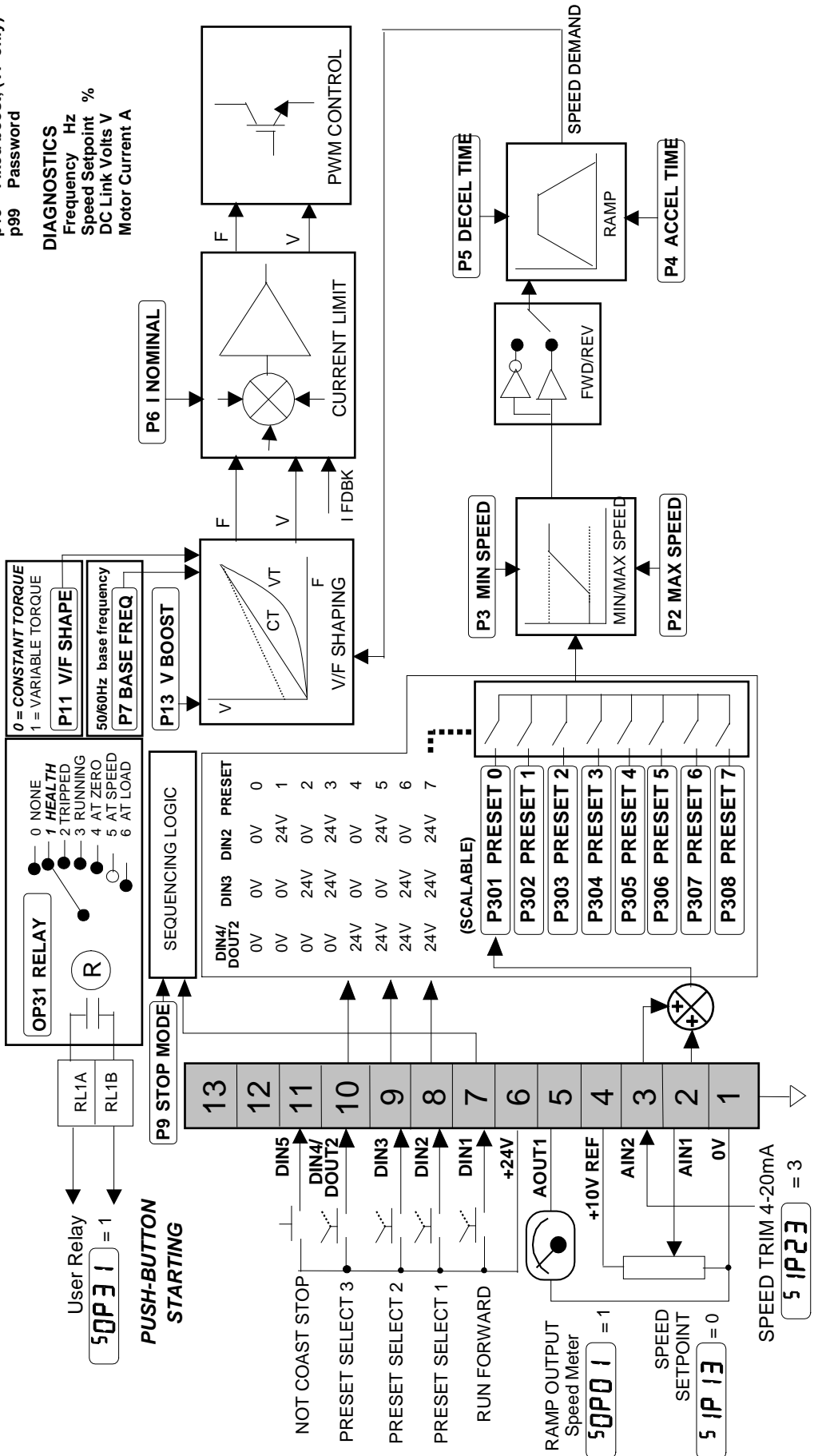
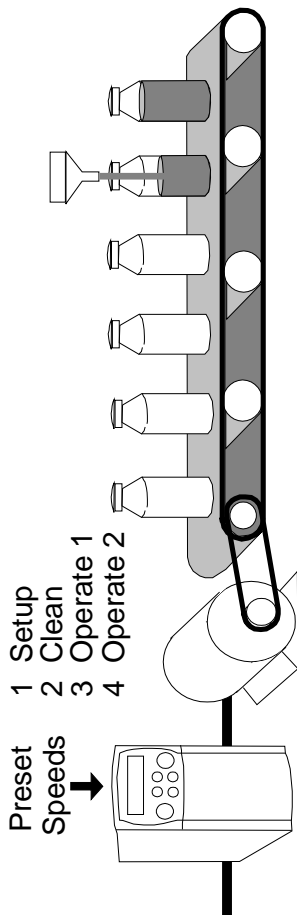

13-7 Applications

Application 3: Preset Speeds

This is ideal for applications requiring multiple discrete speed levels.

The setpoint is selected from either the sum of the analogue inputs, (as in Application 1 and known here as PRESET 0), or as one of up to seven other pre-defined speed levels. These are selected using DIN2, DIN3 and DIN4, refer to the Truth Table below.

Edit parameters P_{302} to P_{308} on the keypad to re-define the speed levels of PRESET 1 to PRESET 7. Reverse direction is achieved by entering a negative speed setpoint.

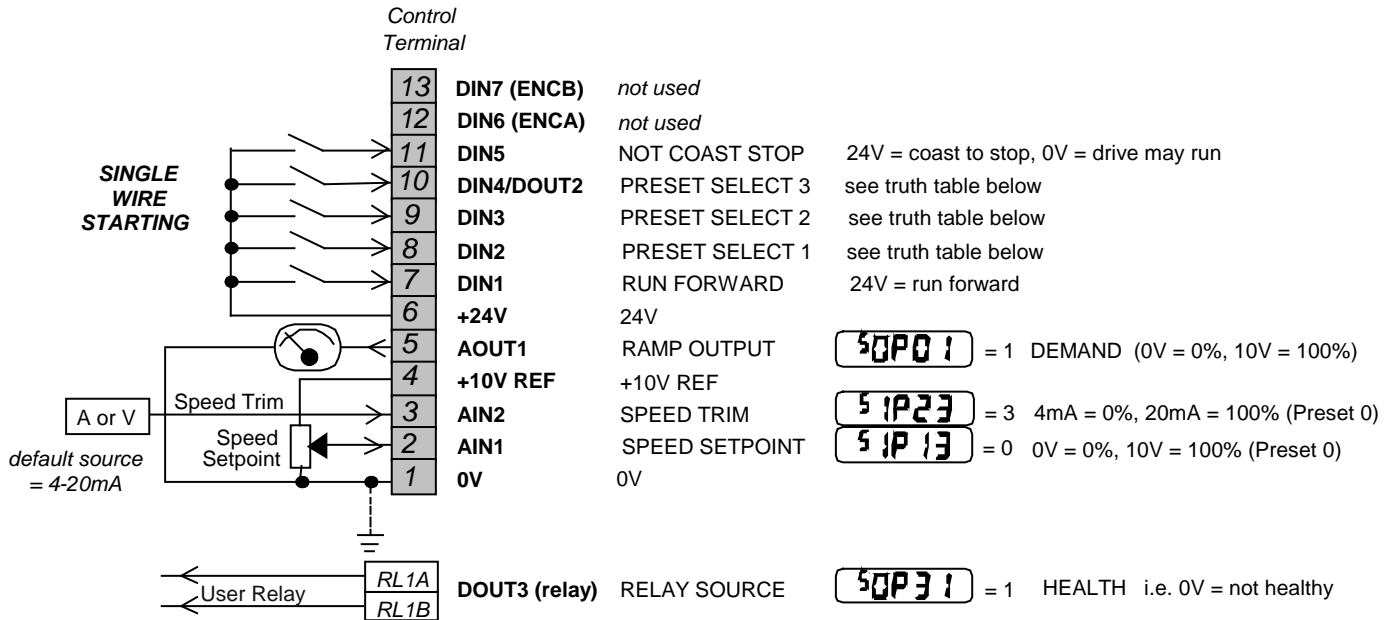

Preset Speed Truth Table

DIN4/DOUT2	DIN3	DIN2	Preset
0V	0V	0V	0
0V	0V	24V	1
0V	24V	0V	2
0V	24V	24V	3
24V	0V	0V	4
24V	0V	24V	5
24V	24V	0V	6
24V	24V	24V	7

Application 4 : Raise/Lower Trim

- STANDARD PARAMETERS**
- p1 Application
 - p2 Max speed
 - p3 Min speed
 - p4 Accel time
 - p5 Decel time
 - p6 Motor current
 - p7 Base frequency
 - p8 Jog setpoint
 - p9 Run stop mode
 - p11 V/F shape
 - p12 Normal duty
 - p13 Fixed boost, (VF only)
 - p99 Password

- DIAGNOSTICS**
- Frequency Hz
 - Speed Setpoint %
 - DC Link Volts V
 - Motor Current A

Application 4: Raise/Lower Trim

IDEAL FOR APPLICATIONS REQUIRING
SPEED CONTROL FROM MULTIPLE LOCATIONS

P I = 4

Italic text indicates Default

User Relay **50P3 I** = 1

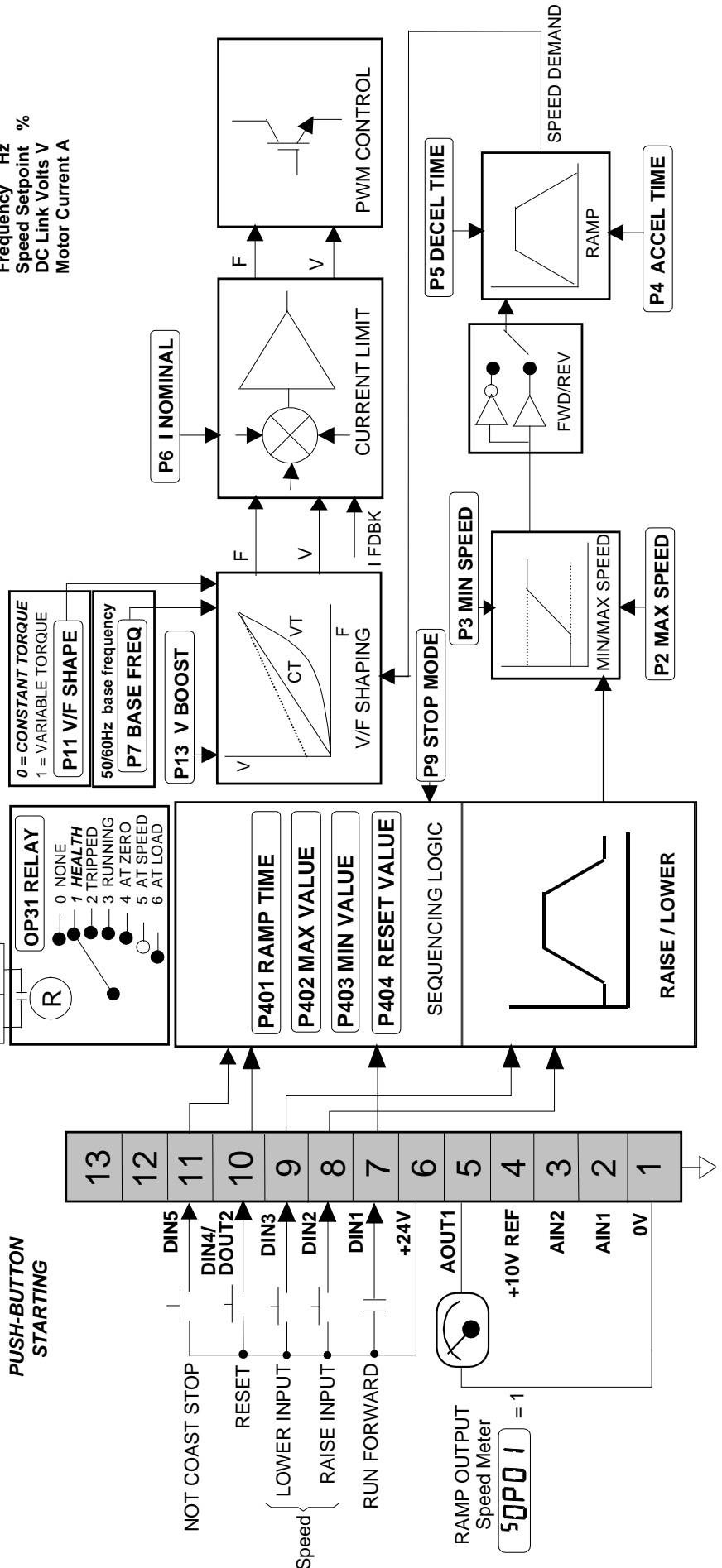
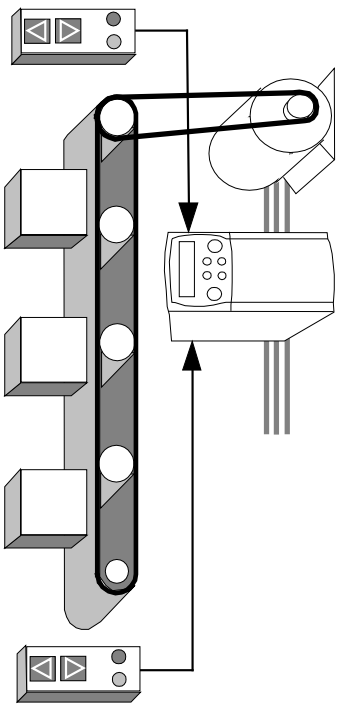

13-9 Applications

Application 4: Raise/Lower Trim

This Application mimics the operation of a motorised potentiometer. Digital inputs allow the setpoint to be increased and decreased between limits. The limits and ramp rate can be set using the keypad.

The Application is sometimes referred to as Motorised Potentiometer.

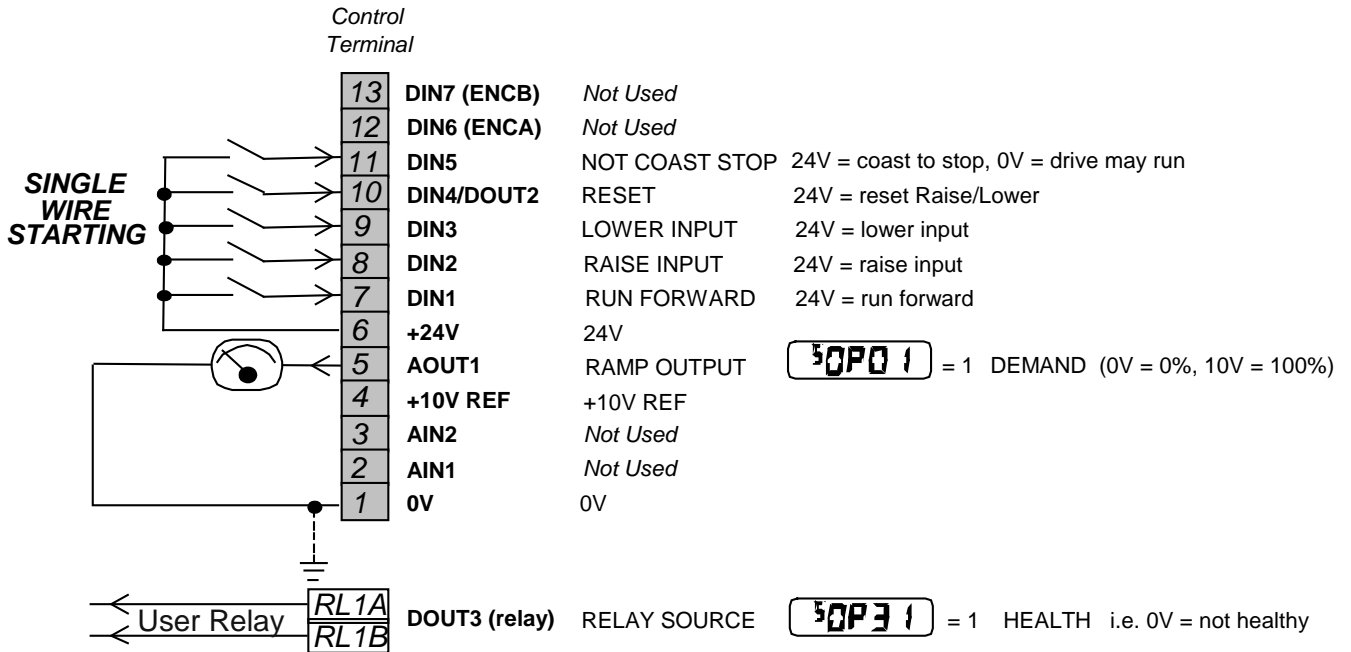

13-11 Applications

Application 5: PID

A simple application using a Proportional-Integral-Derivative 3-term controller. The setpoint is taken from AIN1, with feedback signal from the process on AIN2. The scale and offset features of the analogue input blocks may be used to correctly scale these signals. The difference between these two signals is taken as the PID error. The output of the PID block is then used as the drive setpoint.

